

Ordering Templates



www.precisionactuator.com

Request for Quotation

Fax: (216) 378-9923

Date: _____

Pages (Including this cover): _____

Customer: _____

Address: _____ City: _____

State/Province: _____ Country: _____ Zip: _____

Contact Name: _____

Phone: _____ Fax: _____

E-mail: _____

Template Title	Quantity
_____	_____
_____	_____
_____	_____

FAX CUSTOMER SERVICE at: (216) 378-9923 with a copy of your drawing or select a template from the following pages that best matches your application requirements.

1. Fill in all available data with tolerance in metric units.
2. If a specification is not on the template, add the applicable dimensions and tolerances desired.
3. If a specification is not required but is on the template, draw a line through it, and mark the item description with N/A.
4. Include additional notes to the template to aid in quoting and manufacturing.

For questions or help in selecting the best solution for your application requirements, please complete the application data sheet on page 50 and fax it to (216) 378-9923 or email to engineering@precisionactuator.com

APPLICATION ENGINEERING at: (800) 321-7800 or email: engineering@precisionactuator.com

These templates are available in pdf format online
www.precisionactuator.com

Nook Industries, Inc.—Precision Actuator Group • 23300 Mercantile Rd., Cleveland, Ohio 44122-5921

Fig.1 Horizontal Axis

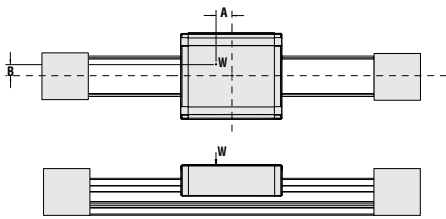

Fig. 2 Vertical Axis

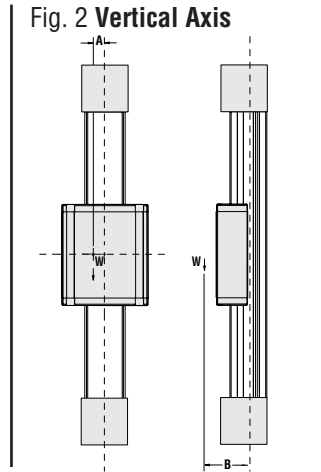
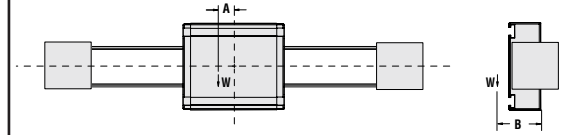

Fig.3 Perpendicular Axis



LENGTH

Length: _____ mm

Orientation:

Fig. 1

Fig. 2

Fig. 3

Horizontal
Axis

Vertical
Axis

Perpendicular
Axis

System Axis: (see pages 138-140, ie: 1a, 1b) _____

LOAD

Total Maximum Dynamic Load: _____ kN A: _____ C: _____ W: _____

Total Maximum Static Load: _____ kN B: _____ D: _____

TRAVEL RATE

Average Speed: _____ m/minute Minimum Speed: _____ m/minute

Maximum Acceptable Speed: _____ mm/minute

DESIRED LIFE

Distance per cycle: _____ mm (usually twice the travel)

Number of cycles: _____ / day _____ / year Desired Life: _____ years

APPLICATION EXPLANATION

Please briefly describe the application with as many details as possible. Include drawing, sketch or order template if available.

Please select a configuration 1a through 1i below that best illustrates your application. Please include on the application data form see page 137.

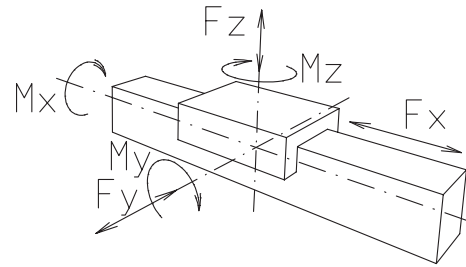

<p>1a</p>	<p>1b</p>	<p>1c</p>
<p>1d</p>	<p>1e</p>	<p>1f</p>
<p>1g</p>	<p>1h</p>	<p>1i</p>

Please select a configuration 2a through 2i below that best illustrates your application. Please include on the application data form see page 137.

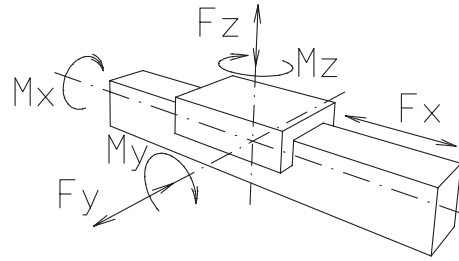

<p>2a</p>	<p>2b</p>	<p>2c</p>
<p>2d</p>	<p>2e</p>	<p>2f</p>
<p>2g</p>	<p>2h</p>	<p>2i</p>

Please select a configuration 3a through 3i below that best illustrates your application. Please include on the application data form see page 137.

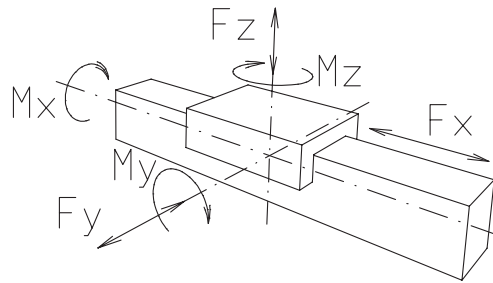

3a 	3b 	3c
3d 3a 	3e 3b 	3f 3c
3g 	3h 	3i

UNIT CONVERSION

ENGLISH TO METRIC

Length

1 ft = 304.8 mm
 1 ft = .3048 m
 1 ft = .0003048 km
 1 in = 25400 μ m
 1 in = 25.4 mm
 1 in = .0254 m
 1 in = .0000254 km

Torque

1 lb-ft = .001356 kN-m
 1 lb-ft = 1.356 N-m
 1 lb-ft = 135.6 N-cm
 1 lb-ft = 1356 N-mm
 1 lb-ft = .1383 kgf-m
 1 lb-in = .000113 k-m
 1 lb-in = .113 N-m
 1 lb-in = .01152 kgf-m

Weight/Force

1 lb = .454 kg
 1 lb = .454 kgf
 1 lb = 4.45 N
 1 lb = .00445 kN

Weight

1 lb/in = 17.9 kg/m
 1 lb/ft = 1.49 kg/m

Speed

1 ft/sec = .3048 m/sec
 1 in/sec = .0254 m/sec

METRIC TO ENGLISH

Length

1 mm = .00328 ft
 1 m = 3.28 ft
 1 km = 3821 ft
 1 μ m = .0000394 in
 1 mm = .03937 in
 1 m = 39.37 in
 1 km = 39370 in

Torque

1 kN-m = 737.3 lb-ft
 1 N-m = .737 lb-ft
 1 N-cm = .00737 lb-ft
 1 N-mm = .000737 lb-ft
 1 kgf-m = 7.23 lb-ft
 1 kN-m = 8847.2 lb-in
 1 N-m = 8.847 lb-ft
 1 kgf-m = 86.8 lb-in

Weight/Force

1 kg = 2.205 lb
 1 kgf = 2.205 lb
 1 N = .225 lb
 1 kN = 224.8 lb

Weight

1 kg/m = .056 lb-in
 1 kg/m = .672 lb-ft

Speed

1 m/sec = 3.28 ft/sec
 1 m/sec = 39.37 in/sec

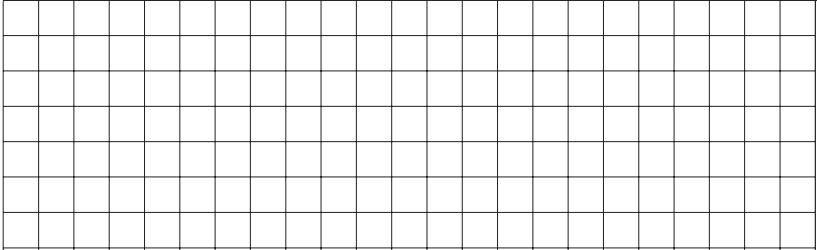
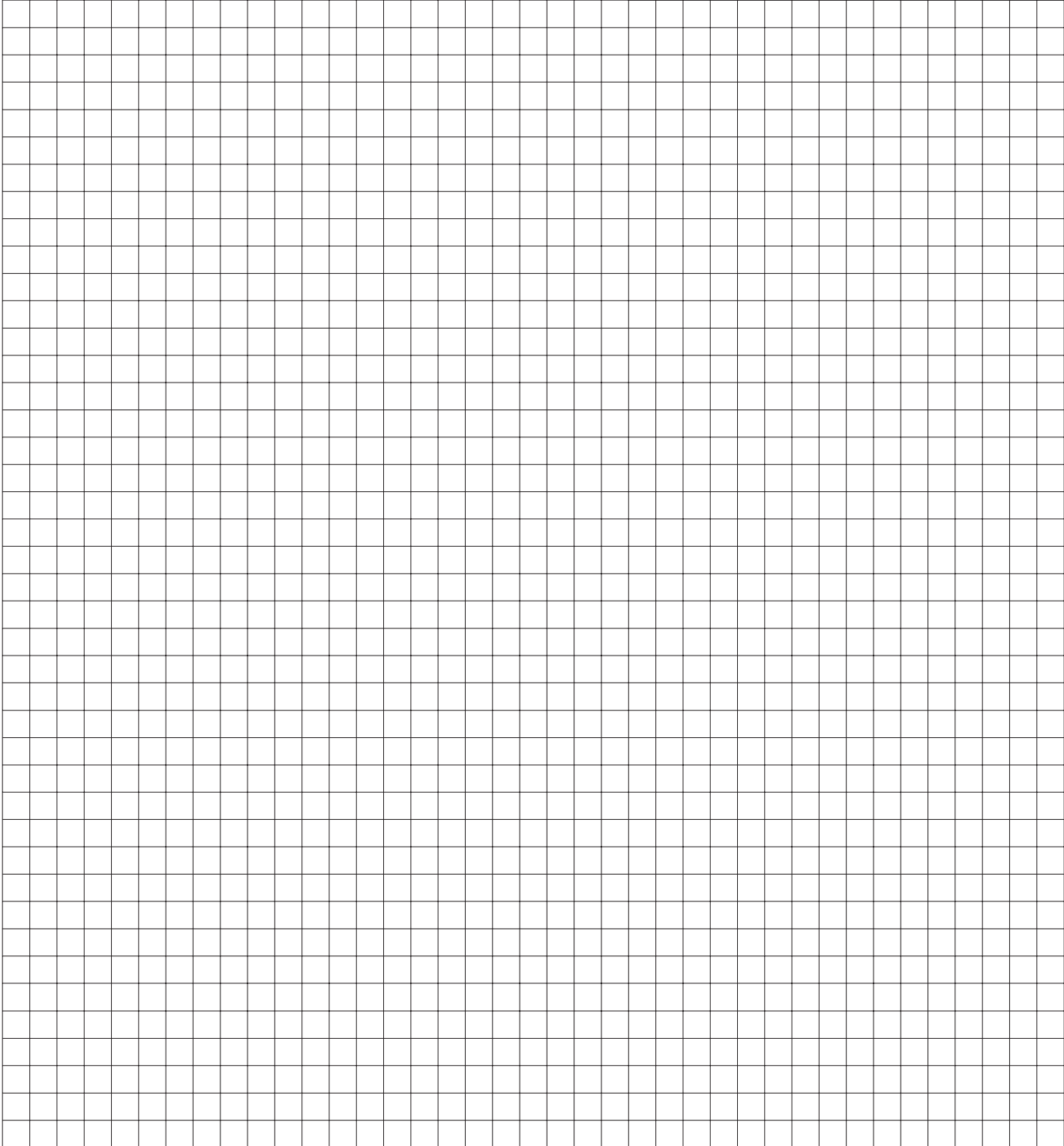
	CUSTOMER NAME: _____
	PROJECT: _____
	PHONE: _____
	FAX: _____
	EMAIL: _____
	

Title	Chapter/Page
EG/EL Modular Linear Actuator Belt or Screw Driven	Chapter 1
EGT – EGK	2-3
EGT – EGK Right-/Left Handed Thread	4
EGTH – EHKH	6-7
EHT – EHK	8-9
ELT – ELK	10-12
EL Modular Linear Actuator without Drive	Chapter 2
ELR	14-15
ELRZ	16
ER	17
E	18-19
UL	20-21
ELZ Modular Linear Actuator External Belt Driven Actuator with Roller Bearing Guidance	Chapter 3
ELZ	24-25
ELZ Carriage Right—Left Moving	26
ELZex	27-28
ELZG	29
ELZZ	30-31
ELSZ with Standard Belt Performance	32-33
ELSZ with Belt Widening	34-35
ELSD with Standard Belt Performance	36-37
ELSD with Belt Widening	38-39
ELZT	40-41
Functioning Drawing for ELZT Units	42-43
ELHZ	44-45
ELVZ	46-47
ELVZ Carriage Right—Left Moving	48
ELFZ	50-51
ELZU	52-53
QL Modular Linear Actuator—Belt Driven	Chapter 4
QLZ	56-57
QLSZ	58-59
QLR	60-61
QS Modular Linear Actuator Belt or Screw Driven Actuator with Profile Rail Guidance	Chapter 5
QSZ	64-65
QSSZ	66-67
QSR	68-69
DL Modular Linear Actuator Belt or Screw Driven Actuator with Profile Rail Guidance	Chapter 6
DLT – DLK	72-73
DLT – DLK Carriage Right—Left Moving	74
DLZ	76-77
DLZT	78-79
DLSZ	80-81
DLR	84-85
DS Modular Linear Actuator Belt or Screw Driven Actuator with Profile Rail Guidance	Chapter 7
DST – DSK	88-89
DST – DSK carriage right - left moving	90
DSZ	92-93
DSSZ	94-95
DSR	96-97

Title	Chapter/Page
DLM/DLVM Linear Motor Carriage with Roller Bearing Guidance	
DS Linear Motor Carriage with Profile Rail Guidance	Chapter 8
DLM	100-101
DLVM	102-103
DSM	104-105
Mounting styles	106
ALLM/ALLZ/ALLR Linear Motor Driven Carriage with Roller Bearing Guidance	Chapter 9
ALLM	108-109
ALLZ	110-111
ALLR	112-113
Accessories	Chapter 10
Square Nuts, T-nuts, Rhombus Nut, Half Round Nut	116
Mounting Possibility	117
Handwheel Positional Indicator Clamp	118
Clamp Mounting Systems	119
Support and Mounting Blocks	120-122
Limit Switch, Proximity Switch	123-124
Activating Strip, Cable Conduit, Cable Chain	125
Coupling, Tension Sets	126
Motor Adapter, Bellows	127
Bevel Gear, Combination Cube, Angular Gear	128
Transmission Unit, Splined Shaft	129
Toothed Pulley, Toothed Belt, Parallel Transfer Unit	130
Incremental Encoder	130
Toothed Belt Gearing	131
Inline and Right Angle Gear Box	132
Belt and Screw Critical Speeds and Application Specifications	Chapter 11
Specifications	134-135
Motors and Control Units	Chapter 12
DC, AC, Stepper and Servo Drives	138
Ordering Templates	Chapter 13
Request for Quotation	140
Application Data Form	141
Single Axis System	142
Two Axis System	143
Three Axis System	144
Unit Conversion	145