

EZZE-MOUNT EZF-4045

Call 800-321-7800 or visit us online at www.nookindustries.com to configure and order your EZZE-MOUNT EZF-4045 today!

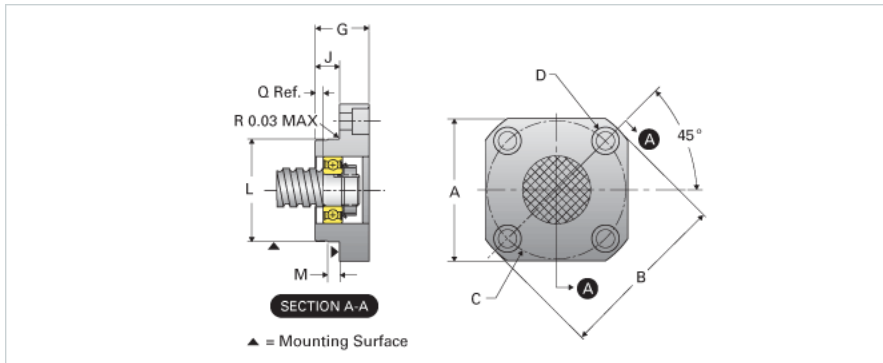
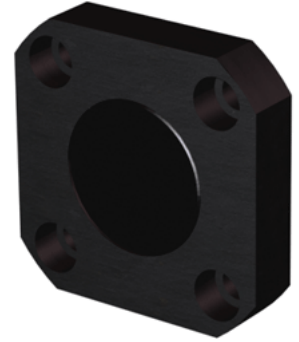

Product Info

Part Number	EZF-4045
Machined End Code	45
Nominal Bearing Journal Size [mm]	45

Dimensions

A [in]	6.50
B - Diameter [in]	7.88
C Bolt Circle [in]	6.313
C Bore [in]	1.25
D Thru [in]	0.781
G [in]	2.50
J [in]	1.25
L Maximum [in]	4.8025
L Minimum [in]	4.8015
M [in]	0.500
Q [in]	0.50

Weight

Weight [lb]	7.00
-------------	------