

## EZZE-MOUNT EZF-3045

Call 800-321-7800 or visit us online at [www.nookindustries.com](http://www.nookindustries.com) to configure and order your EZZE-MOUNT EZF-3045 today!

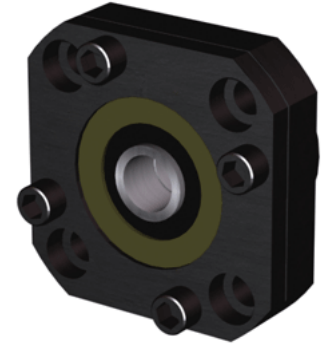
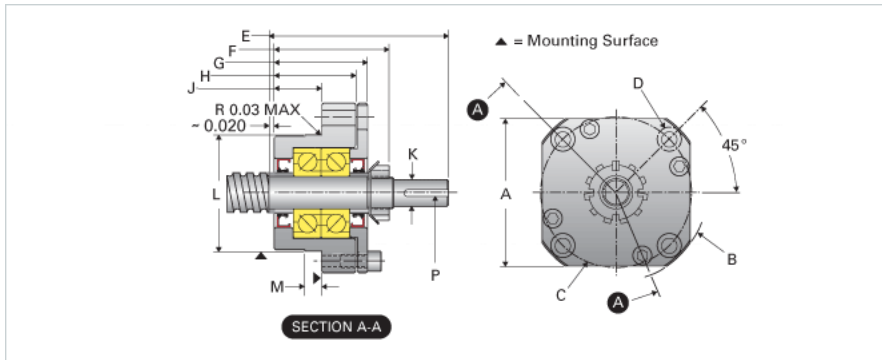

### Product Info

Part Number	EZF-3045
Machined End Code	45
Nominal Bearing Journal Size [mm]	45

### Dimensions

A [in]	6.50
B - Diameter [in]	7.88
C Bolt Circle [in]	6.31
C Bore [in]	1.25
D Thru [in]	0.781
E [in]	6.68
F [in]	4.47
G [in]	4.01
H [in]	3.22
J [in]	1.97
K Shaft Diameter Maximum [in]	1.375
K Shaft Diameter Minimum [in]	1.374
L Minimum [in]	4.8025
L Maximum [in]	4.8015
M [in]	0.500
P [in]	0.313
Q [in]	0.50

### Weight

Weight [lb]	8.00
-------------	------