

## G3-BSJ-U 3:1

Call 800-321-7800 or visit us online at [www.nookindustries.com](http://www.nookindustries.com) to configure and order your G3-BSJ-U 3:1 today!

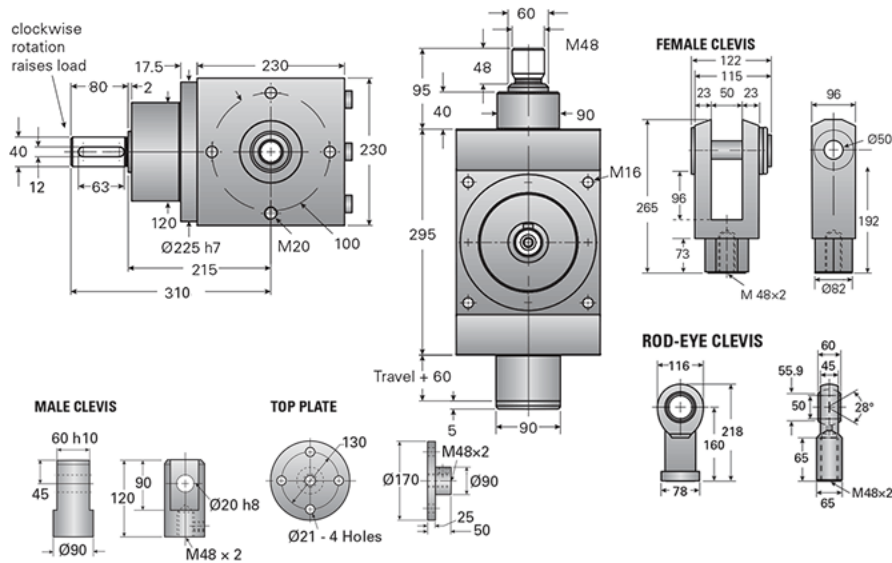

### Details

|                                 |       |
|---------------------------------|-------|
| Capacity [kN]                   | 90    |
| Gear Ratio                      | 3:1   |
| Raise for One Turn of Worm [mm] | 3.33  |
| Torque to Raise 1 kN [Nm]       | 0.71  |
| Tare Drag Torque [Nm]           | 4.30  |
| Lifting Screw Diameter [mm]     | 63    |
| Screw Lead [mm]                 | 10    |
| BackDrive Holding Torque [Nm]   | 31.47 |

### Performance Specifications

|                           |      |
|---------------------------|------|
| Maximum Input Torque [Nm] | 1600 |
| Dynamic Load Ca [kN]      | 76.0 |

### Weight

|                          |       |
|--------------------------|-------|
| Base 0 Travel [kg]       | 36.30 |
| Per 100mm of Travel [kg] | 2.12  |
| Grease [kg]              | 1.00  |