

## G3-BSJ-U 2:1

Call 800-321-7800 or visit us online at [www.nookindustries.com](http://www.nookindustries.com) to configure and order your G3-BSJ-U 2:1 today!

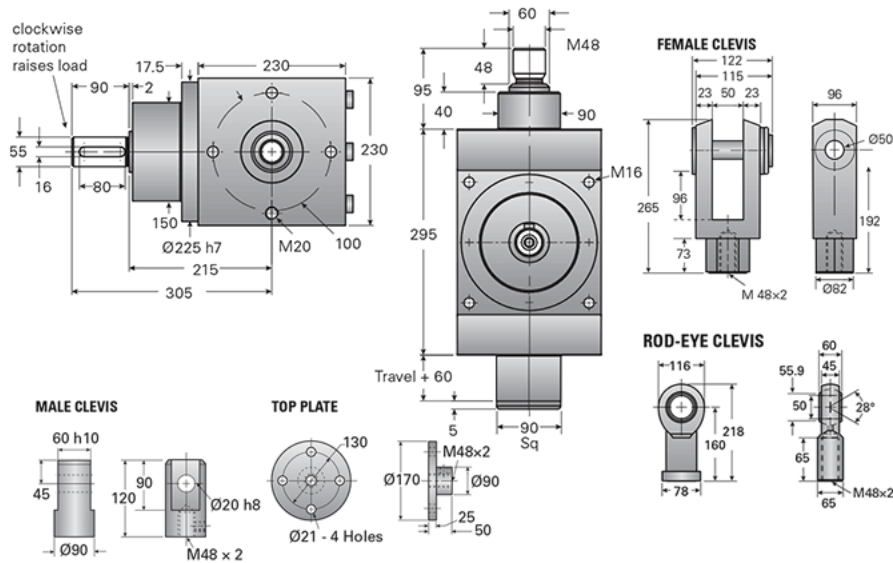

### Details

Capacity [kN]	90
Gear Ratio	2:1
Raise for One Turn of Worm [mm]	5.00
Torque to Raise 1 kN [Nm]	1.06
Tare Drag Torque [Nm]	4.40
Lifting Screw Diameter [mm]	63
Screw Lead [mm]	10
BackDrive Holding Torque [Nm]	38.57

### Performance Specifications

Maximum Input Torque [Nm]	1600
Dynamic Load Ca [kN]	76.0

### Weight

Base 0 Travel [kg]	36.30
Per 100mm of Travel [kg]	2.12
Grease [kg]	1.00