

MBN32x32R-4CW

Call 800-321-7800 or visit us online at www.nookindustries.com to configure and order your MBN32x32R-4CW today!

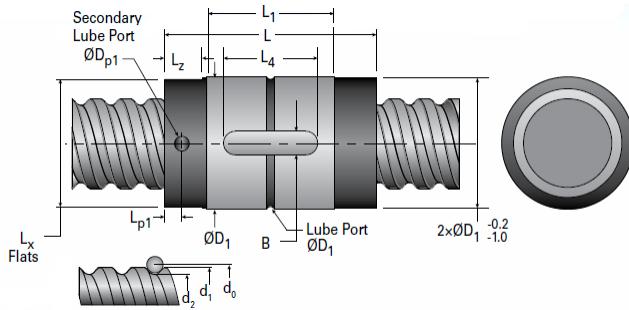

Product Info

Nominal Rod Diameter [mm]	32
Material	Alloy
Thread Direction	RH

Details

Lead [mm]	32
Active Turns	4
Nominal Ball Dia. [mm]	3.969
Screw Weight [kg/m]	5.54
Nut Weight [kg]	0.57
End Code for Types 1,2, and 3	25
End Code for Types 4	16
End Code for Types 5	25
End Code for Types 6	25
End Code for Types 7	25

Performance Specifications

Dynamic Load Ca [N]	18020
Static Load [N]	41150
Linear Speed (Based on DN Values) [mm/min]	70000

Screw Dimensions

d0 [mm]	32
d1 [mm]	31.17
d2 [mm]	27.90

Nut Dimensions

D1 (g6) [mm]	56
L1 [mm]	30
Dp [mm]	2.4
Lp1 [mm]	-
Dp1 [mm]	-
L [mm]	50
Lx [mm]	54
Lz [mm]	5
L4 [mm]	25
B (P9) [mm]	5