

MBN25X5R-4CW

Call 800-321-7800 or visit us online at www.nookindustries.com to configure and order your MBN25X5R-4CW today!

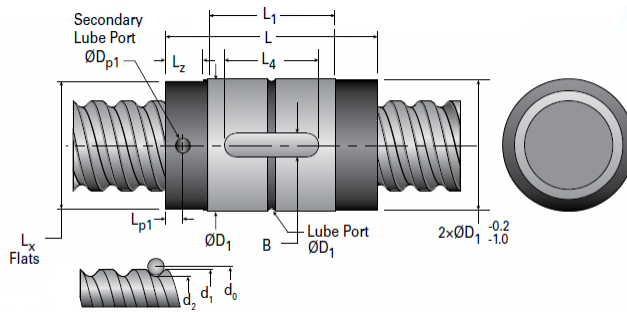

Product Info

Nominal Rod Diameter [mm]	25
Material	Alloy
Thread Direction	RH

Details

Lead [mm]	5
Active Turns	4
Nominal Ball Dia. [mm]	3.500
Screw Weight [kg/m]	3.21
Nut Weight [kg]	0.19
End Code for Types 1,2, and 3	20
End Code for Types 4	12
End Code for Types 5	20
End Code for Types 6	20
End Code for Types 7	20

Performance Specifications

Dynamic Load Ca [N]	16380
Static Load [N]	32880
Linear Speed (Based on DN Values) [mm/min]	14000

Screw Dimensions

d0 [mm]	25
d1 [mm]	24.26
d2 [mm]	21.38

Nut Dimensions

D1 (g6) [mm]	38
L1 [mm]	25
Dp [mm]	1.5
Lp1 [mm]	-
Dp1 [mm]	-
L [mm]	46
Lx [mm]	36
Lz [mm]	7
L4 [mm]	20
B (P9) [mm]	5