

## 252-12-LXX/0750-0500 SRT RA

Call 800-321-7800 or visit us online at [www.nookindustries.com](http://www.nookindustries.com) to configure and order your 252-12-LXX/0750-0500 SRT RA today!

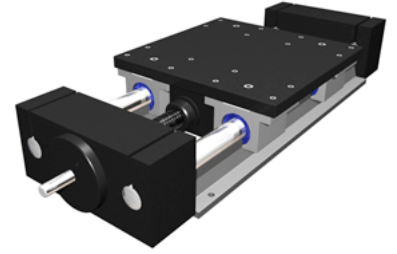

### Product Info

|                             |               |
|-----------------------------|---------------|
| Nominal Shaft Diameter [in] | 0.75          |
| Screw Type                  | Ball          |
| Screw Size                  | 0750-0500 SRT |

### Dimensions

|                 |            |
|-----------------|------------|
| A +/-0.003 [in] | 2.938      |
| A1 [in]         | 2.75       |
| B [in]          | 6.00       |
| C [in]          | 1.75       |
| C1 [in]         | 0.25       |
| D [in]          | 4.50       |
| E [in]          | 1.50       |
| F [in]          | 2.0        |
| H [in]          | 3.00       |
| J +/-0.010 [in] | 6.000      |
| K +/-0.010 [in] | 1.250      |
| M - Bolt        | #10        |
| M - Hole [in]   | 0.22       |
| N [in]          | 7.50       |
| P [in]          | 7.50       |
| S [in]          | 6.00       |
| U [in]          | 4.50       |
| V               | 5/16-18    |
| W [in]          | 0.50       |
| X [in]          | 1.50       |
| Y [in]          | 0.500      |
| Z               | .81 x .140 |
| A2 [in]         | 1.020      |

### Dimensions

|                                   |      |
|-----------------------------------|------|
| Minimum L Dimension TRAVEL + [in] | 11.5 |
|-----------------------------------|------|

### Performance specifications

|                           |      |
|---------------------------|------|
| Load Maximum System [lbf] | 2040 |
|---------------------------|------|