

## 252-16-LXX/111 RA

Call 800-321-7800 or visit us online at [www.nookindustries.com](http://www.nookindustries.com) to configure and order your 252-16-LXX/111 RA today!

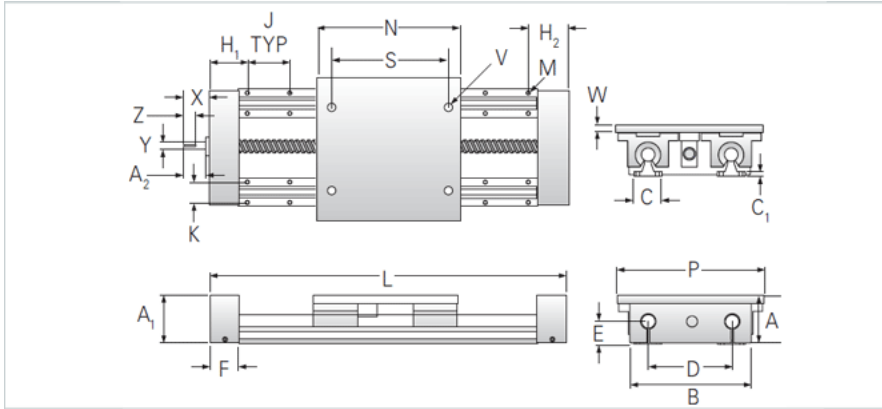
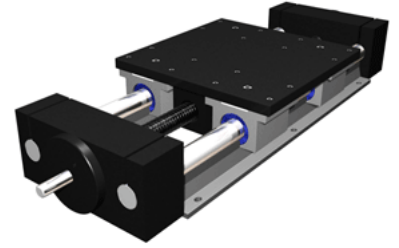

### Product Info

Nominal Shaft Diameter [in]	1.00
Screw Type	Acme
Screw Size	1-1

### Dimensions

A +/-0.003 [in]	3.438
A1 [in]	3.25
B [in]	7.25
C [in]	2.13
C1 [in]	0.25
D [in]	5.50
E [in]	1.75
F [in]	2.2
H [in]	3.00
J +/-0.010 [in]	6.000
K +/-0.010 [in]	1.500
M - Bolt	1/4
M - Hole [in]	0.28
N [in]	9.00
P [in]	9.00
S [in]	7.00
U [in]	5.50
V	3/8-16
W [in]	0.50
X [in]	1.74
Y [in]	0.625
Z	1.03 x .188
A2 [in]	1.260

### Dimensions

Minimum L Dimension TRAVEL + [in]	13.4
-----------------------------------	------

### Performance specifications

Load Maximum System [lbf]	3320
---------------------------	------