

212-08-LXX/0500-0500 SRT RA

Call 800-321-7800 or visit us online at www.nookindustries.com to configure and order your 212-08-LXX/0500-0500 SRT RA today!

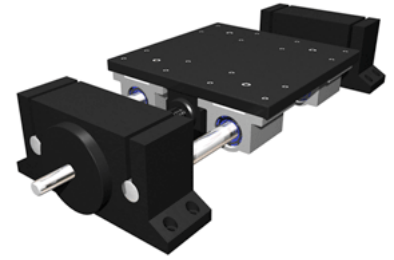
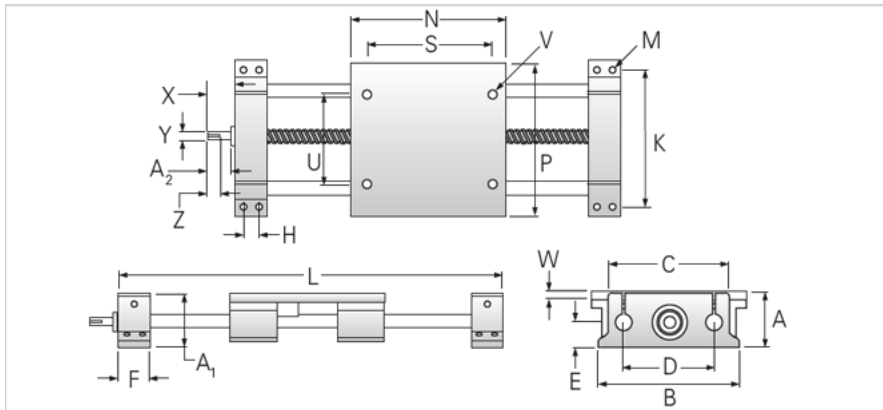

Product Info

Nominal Shaft Diameter [in]	0.50
Screw Type	Ball
Screw Size	0500-0500 SRT

Dimensions

A +/-0.003 [in]	2.187
A1 [in]	2.38
B [in]	5.30
C [in]	4.25
D [in]	3.25
E [in]	1.13
F [in]	1.50
H +/-0.010 [in]	0.750
K +/-0.010 [in]	4.800
M - Bolt	#8
M - Hole [in]	0.19
N [in]	5.50
P [in]	5.50
S [in]	4.50
U [in]	3.25
V	1/4-20
W [in]	0.38
X [in]	1.00
Y [in]	0.250
Z	.51 x .095
A2 [in]	0.665

Dimensions

Minimum L Dimension TRAVEL + [in]	8.5
-----------------------------------	-----

Performance specifications

Load Maximum System [lbf]	700
---------------------------	-----