

212-24-LXX/154 RA

Call 800-321-7800 or visit us online at www.nookindustries.com to configure and order your 212-24-LXX/154 RA today!

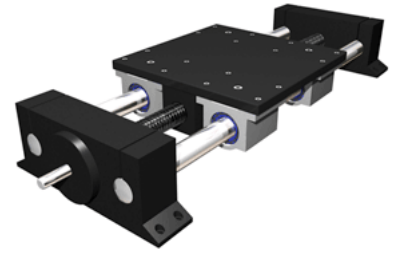
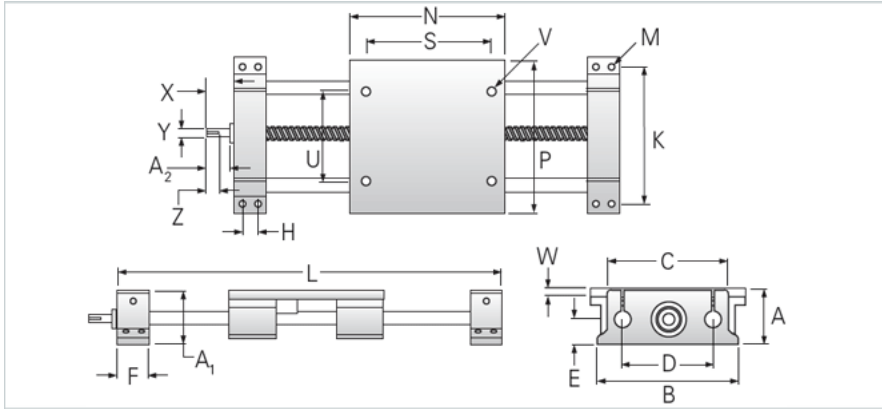

Product Info

Nominal Shaft Diameter [in]	1.50
Screw Type	Acme
Screw Size	1 1/2-4

Dimensions

A +/-0.003 [in]	5.000
A1 [in]	4.97
B [in]	13.00
C [in]	10.75
D [in]	8.00
E [in]	2.50
F [in]	2.80
H +/-0.010 [in]	1.500
K +/-0.010 [in]	12.000
M - Bolt	5/16
M - Hole [in]	0.34
N [in]	13.00
P [in]	13.00
S [in]	10.00
U [in]	8.00
V	1/2-15
W [in]	2.75
X [in]	2.32
Y [in]	0.750
Z	1.14 x .188
A2 [in]	1.657

Dimensions

Minimum L Dimension TRAVEL + [in]	18.6
-----------------------------------	------

Performance specifications

Load Maximum System [lbf]	5504
---------------------------	------