

## 212-24-LXX/152 RA

Call 800-321-7800 or visit us online at [www.nookindustries.com](http://www.nookindustries.com) to configure and order your 212-24-LXX/152 RA today!

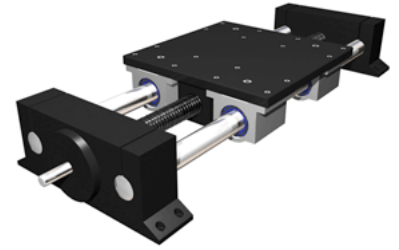
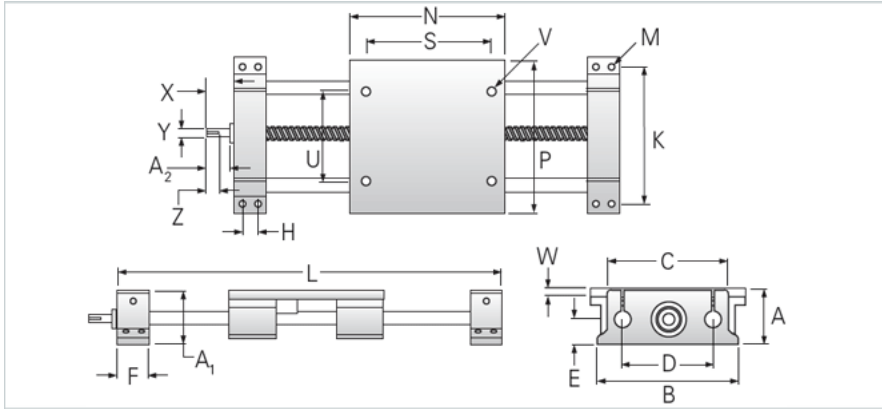

### Product Info

|                             |         |
|-----------------------------|---------|
| Nominal Shaft Diameter [in] | 1.50    |
| Screw Type                  | Acme    |
| Screw Size                  | 1 1/2-2 |

### Dimensions

|                 |             |
|-----------------|-------------|
| A +/-0.003 [in] | 5.000       |
| A1 [in]         | 4.97        |
| B [in]          | 13.00       |
| C [in]          | 10.75       |
| D [in]          | 8.00        |
| E [in]          | 2.50        |
| F [in]          | 2.80        |
| H +/-0.010 [in] | 1.500       |
| K +/-0.010 [in] | 12.000      |
| M - Bolt        | 5/16        |
| M - Hole [in]   | 0.34        |
| N [in]          | 13.00       |
| P [in]          | 13.00       |
| S [in]          | 10.00       |
| U [in]          | 8.00        |
| V               | 1/2-13      |
| W [in]          | 0.75        |
| X [in]          | 2.32        |
| Y [in]          | 0.750       |
| Z               | 1.14 x .188 |
| A2 [in]         | 1.657       |

### Dimensions

|                                   |      |
|-----------------------------------|------|
| Minimum L Dimension TRAVEL + [in] | 18.6 |
|-----------------------------------|------|

### Performance specifications

|                           |      |
|---------------------------|------|
| Load Maximum System [lbf] | 5504 |
|---------------------------|------|