

## NIA5-230-40-A

Call 800-321-7800 or visit us online at [www.nookindustries.com](http://www.nookindustries.com) to configure and order your NIA5-230-40-A today!

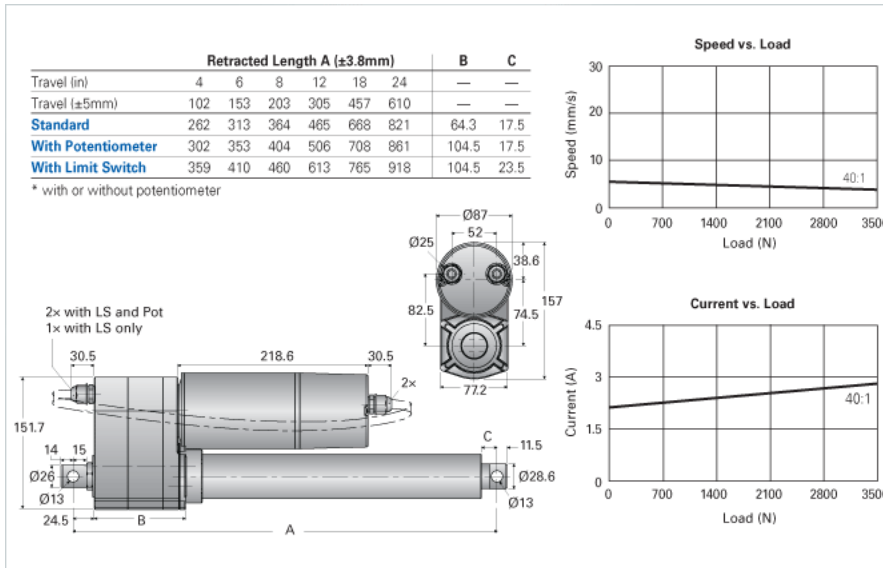

### Product Info

Screw Type

Acme Screw

### Details

Voltage [VAC]

230

Hertz [Hz]

50

Gear Ratio

40:1

Speed At No Load [mm/s]

8

Speed At Full Load [mm/s]

7

Load Capacity Dynamic Load [N]

3500

Load Capacity Static Load [N]

4500

Amps

2.8

### Performance Specifications

Duty Cycle [% of 5 Minutes]

25

Protection Class

IP65