

## NIA5-115-20-B

Call 800-321-7800 or visit us online at [www.nookindustries.com](http://www.nookindustries.com) to configure and order your NIA5-115-20-B today!

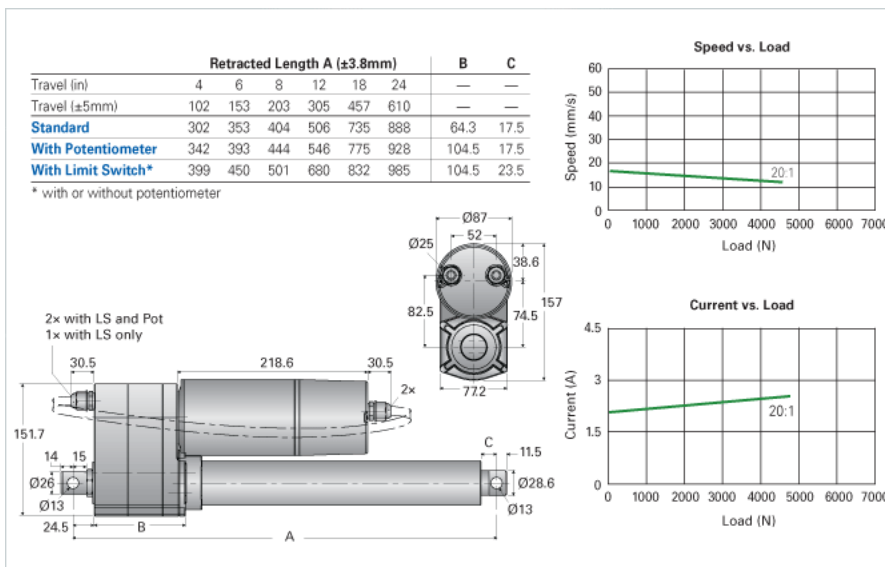

### Product Info

Screw Type

Ball Screw

### Details

Voltage [VAC]

115

Hertz [Hz]

60

Gear Ratio

20:1

Speed At No Load [mm/s]

15

Speed At Full Load [mm/s]

13

Load Capacity Dynamic Load [N]

4500

Load Capacity Static Load [N]

13600

Amps

2.2

### Performance Specifications

Duty Cycle [% of 5 Minutes]

25

Protection Class

IP65