

CCU58-A8 B

Call 800-321-7800 or visit us online at www.nookindustries.com to configure and order your CCU58-A8 B today!

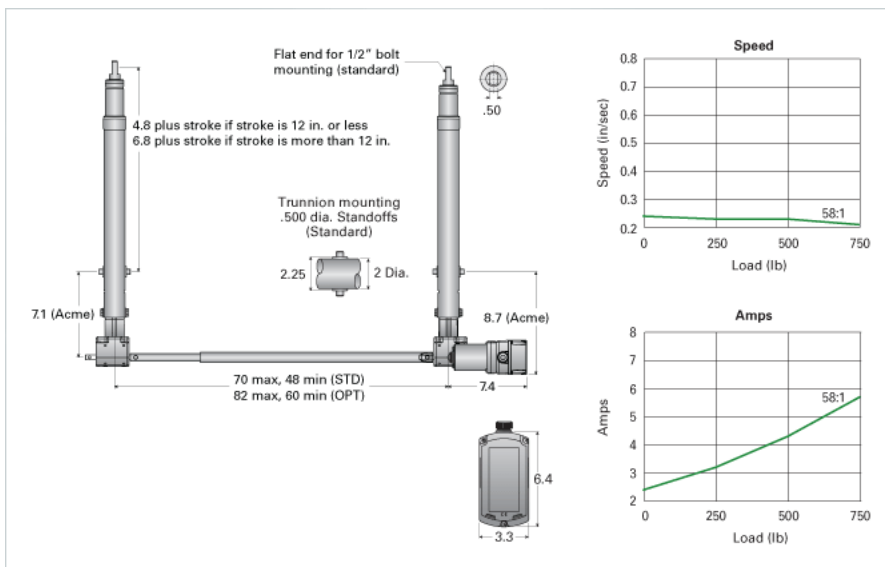

Product Info

Screw Type

Acme Screw

Details

Screw Size

5/8-5 RA

Voltage

24 VDC

Gear Ratio

58:1

Load Capacity [lb]

750

Speed [in/sec]

0.2

Amps

6

Maximum Cylinder Width [in]

70

Minimum Cylinder Width [in]

48

Performance Specifications

Duty Cycle [% of 5 Minutes]

25

Protection Class

IP54

Maximum Temperature Range [F°]

160

Minimum Temperature Range [F°]

-30