

QSKE 80

Call 800-321-7800 or visit us online at www.nookindustries.com to configure and order your QSKE 80 today!

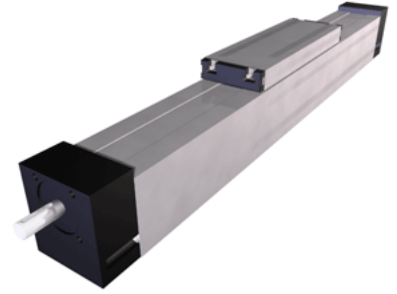
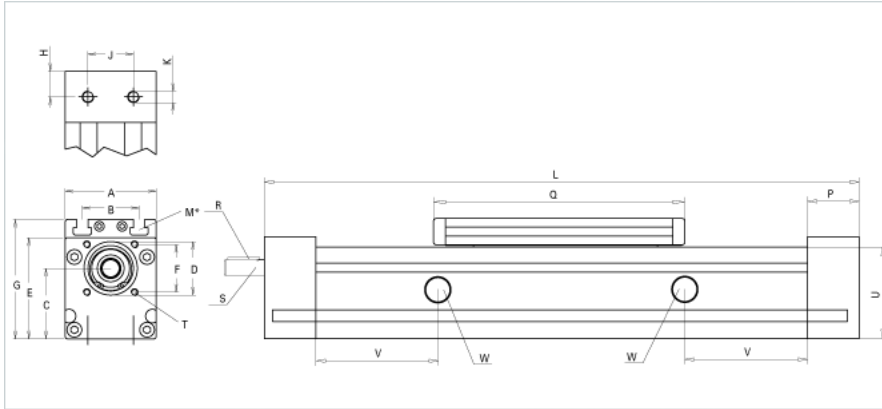

Details	
Size	80
Screw Options	25x5/20x20/25x10
Screw Type	Ball Screw
Dimensions	
Basic Length L [mm]	350
A [mm]	81
B [mm]	50
C [mm]	62.5
D [mm]	47
E [mm]	89.5
F [mm]	42
G [mm]	107
H [mm]	22.5
J [mm]	40
K	M10
N	M8
P [mm]	45
Q [mm]	250
Shaft R Key [mm]	5x5x28
Shaft S Diameter x Length [mm]	14h6x35
T	M6
U [mm]	81
Forces and Torques	
F _x [N] 10000 km	2000
F _y [N] 10000 km	2542
F _z [N] 10000 km	6050
M _x [Nm] 10000 km	76
M _y [Nm] 10000 km	430
M _z [Nm] 10000 km	392
F _x [N] 5000 km	2500
F _y [N] 5000 km	3570
F _z [N] 5000 km	8500
M _x [Nm] 5000 km	107
M _y [Nm] 5000 km	604
M _z [Nm] 5000 km	550
Geometrical moments of inertia of aluminum profile	
Elastic modulus [N/mm ²]	70000
I _x [mm ⁴]	1400000
I _y [mm ⁴]	1660000
Weight	
Weight Per 100 mm [kg]	0.9
Basic Weight [kg]	7.5