

## ELZQ 60 h7 WAC

Call 800-321-7800 or visit us online at [www.nookindustries.com](http://www.nookindustries.com) to configure and order your ELZQ 60 h7 WAC today!

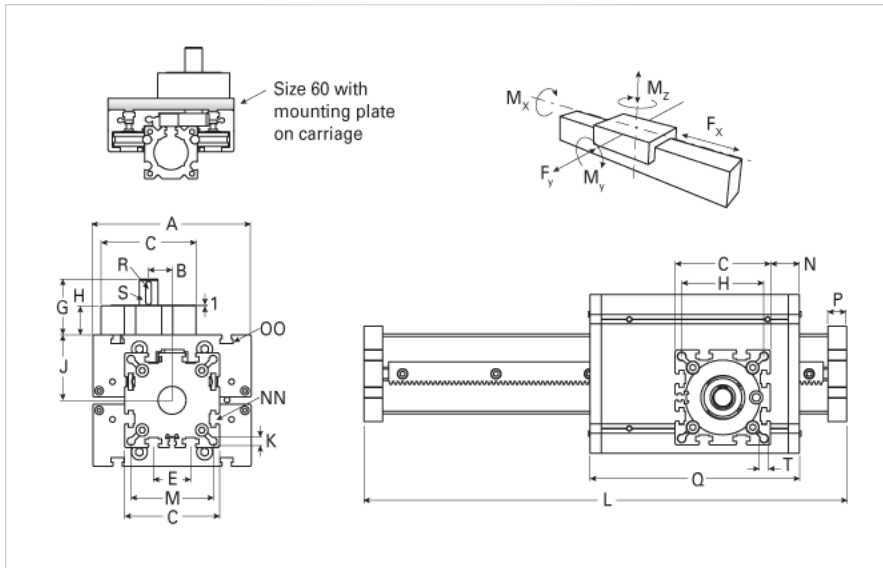
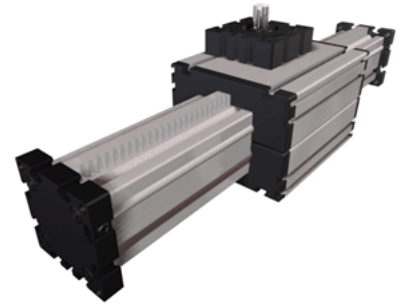

<b>Details</b>	
Size	60
<b>Dimensions</b>	
Basic Length L [mm]	246
A [mm]	144
B [mm]	25.5
C [mm]	82
D [mm]	62
E [mm]	30
G [mm]	71.5
H [mm]	42
J [mm]	49
K [mm]	8.5
M [mm]	69
N [mm]	32
NN	M8
OO	M8
P [mm]	16
Q [mm]	210
T	M10
<b>Speed</b>	
Speed Maximum [m/s]	4
<b>Forces and Torques</b>	
Fx dynamic [N]	780
Fy dynamic [N]	2000
Fz dynamic [N]	1100
Mx dynamic [Nm]	43
My dynamic [Nm]	70
Mz dynamic [Nm]	100
Fx static [N]	940
Fy static [N]	3000
Fz static [N]	1700
Mx static [Nm]	67
My static [Nm]	90
Mz static [Nm]	120
<b>Geometrical moments of inertia of aluminum profile</b>	
Elastic modulus [N/mm <sup>2</sup> ]	70000
Ix [mm <sup>4</sup> ]	679000
Iy [mm <sup>4</sup> ]	697000
<b>Weight</b>	
Additional Weight per 100 mm [kg]	0.68
Basic Weight [kg]	5.3