

RAD-10086-A2

Call 800-321-7800 or visit us online at www.nookindustries.com to configure and order your RAD-10086-A2 today!

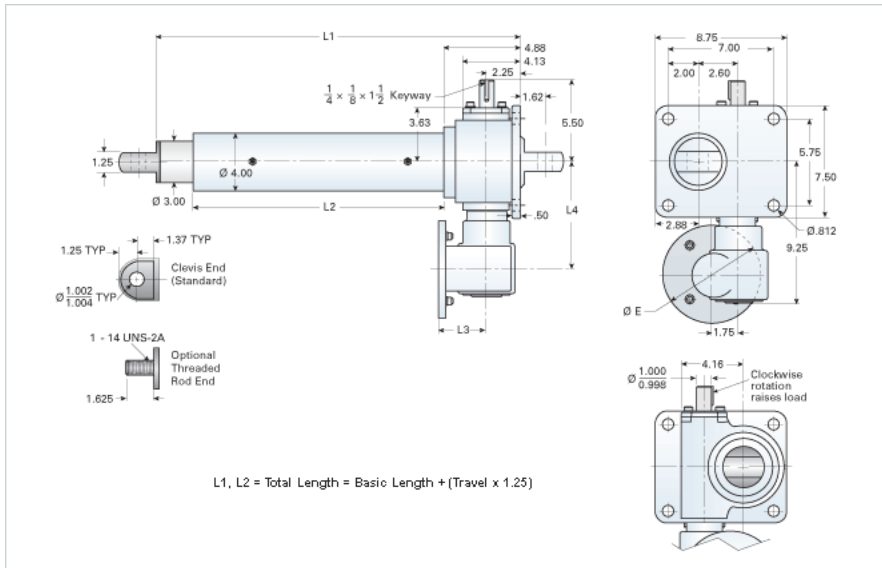

Details

Gear Ratio Primary Reduction	8:1
Gear Ratio Secondary Reduction	6:1
Max Capacity [lb]	20000
Input Turns per Inch of Travel	96
Torque to Raise 1 lb. [in-lb]	0.0096
Acme Screw	2-2 RA
Screw Lead [in]	0.500
Root Diameter [in]	1.410
Max HP [hp]	1

Weight

Basic Weight [lb]	89
Per Inch of Travel [lb]	2.50

Tube Dimensions

L1 Basic Length [in]	12.88
L2 Basic Length [in]	6.50

NEMA 56C Dimensions

L3 [in]	3.69
L4 [in]	5.63
E [in]	6.69

NEMA 180TC Dimensions

L3 [in]	-
L4 [in]	-
F [in]	-