

RAD-10046-HD

Call 800-321-7800 or visit us online at www.nookindustries.com to configure and order your RAD-10046-HD today!

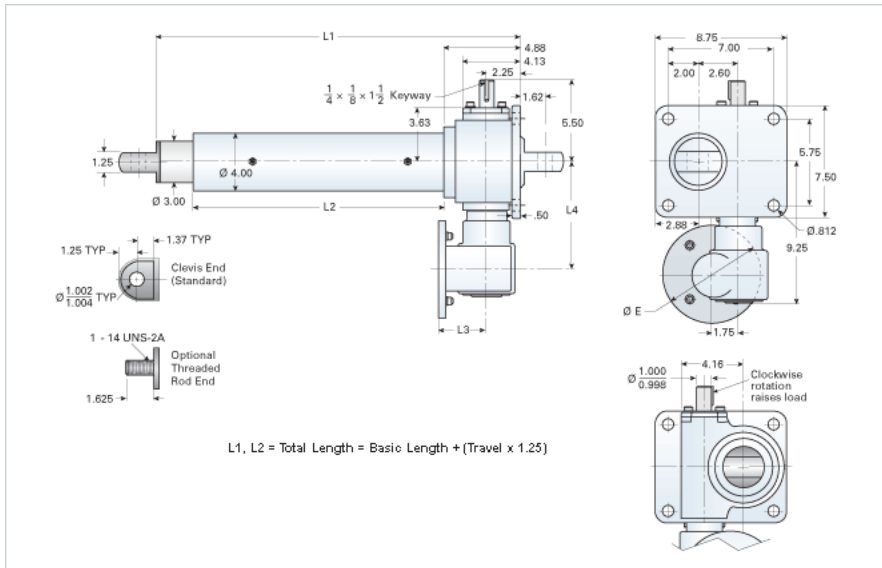

Details

Gear Ratio Primary Reduction	24:1
Gear Ratio Secondary Reduction	6:1
Max Capacity [lb]	20000
Input Turns Per Inch Of Travel	303.96
Torque To Raise 1 lb. [in-lb]	0.002
Ball Screw	1500-0473 SRT RA
Screw Lead [in]	0.413
Root Diameter [in]	1.140
Max HP [hp]	1

Weight

Basic Weight [lb]	93
Per Inch of Travel [lb]	1.92

Tube Dimensions

L1 Basic Length [in]	15.25
L2 Basic Length [in]	8.88

NEMA 56C Dimensions

L3 [in]	3.69
L4 [in]	7.25
E [in]	6.69

NEMA 180TC Dimensions

L3 [in]	-
L4 [in]	-
F [in]	-