

RAD-2562-HL

Call 800-321-7800 or visit us online at www.nookindustries.com to configure and order your RAD-2562-HL today!

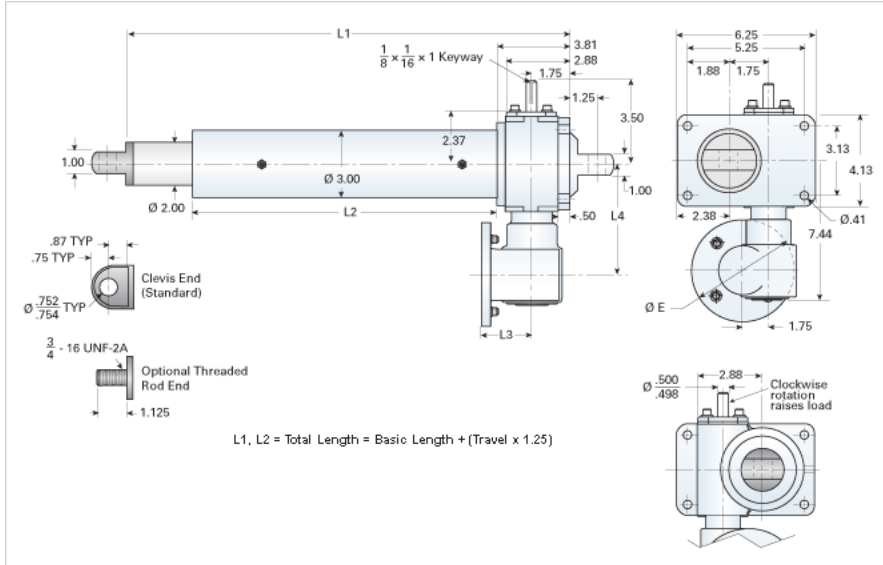

Details

Gear Ratio Primary Reduction	6:1
Gear Ratio Secondary Reduction	12:1
Max Capacity [lb]	5000
Input Turns Per Inch Of Travel	72
Torque To Raise 1 lb. [in-lb]	0.0037
Ball Screw	1000-1000 SRT RA
Screw Lead [in]	1.000
Root Diameter [in]	0.820
Max HP [hp]	1

Weight

Basic Weight [lb]	46
Per Inch of Travel [lb]	1.05

Tube Dimensions

L1 Basic Length [in]	12.44
L2 Basic Length [in]	7.13

NEMA 56C Dimensions

L3 [in]	3.69
L4 [in]	5.63
E [in]	6.69

NEMA 180TC Dimensions

L3 [in]	-
L4 [in]	-
F [in]	-