

## DD-2008-A2

Call 800-321-7800 or visit us online at [www.nookindustries.com](http://www.nookindustries.com) to configure and order your DD-2008-A2 today!

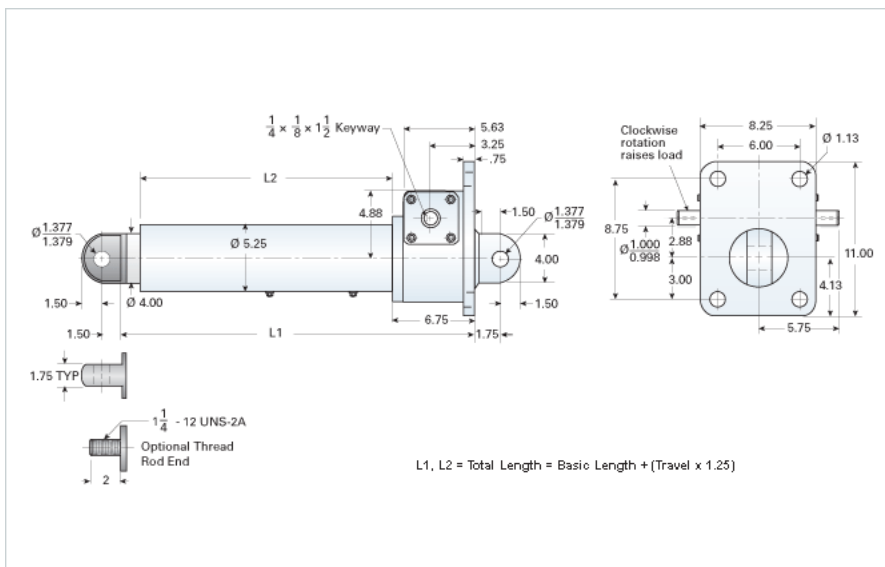

### Details

Gear Ratio	8:1
Max Capacity [lb]	40000
Input Turns Per Inch Of Travel	16
Torque To Raise 1 lb. [in-lb]	0.0435
Acme Screw	2 1/2-2 RA
Screw Lead [in]	0.500
Root Diameter [in]	1.908
Max HP [hp]	7.5

### Weight

Basic Weight [lb]	138
Per Inch of Travel [lb]	3.60

### Tube Dimensions

L1 Basic Length [in]	17.44
L2 Basic Length [in]	8.94

### NEMA 42 Dimensions

L3 [in]	-
E [in]	-
F [in]	-

### NEMA 48 Dimensions

L3 [in]	-
E [in]	-
F [in]	-

### NEMA 56C Dimensions

L3 [in]	8.65
E [in]	6.75
F [in]	5.19

### NEMA 182TC Dimensions

L3 [in]	-
E [in]	-
F [in]	-

### NEMA 184TC Dimensions

L3 [in]	9.00
E [in]	9.25
F [in]	5.18

### NEMA 213TC Dimensions

L3 [in]	9.65
E [in]	9.25
F [in]	5.69