

## DD-5024-HL

Call 800-321-7800 or visit us online at [www.nookindustries.com](http://www.nookindustries.com) to configure and order your DD-5024-HL today!

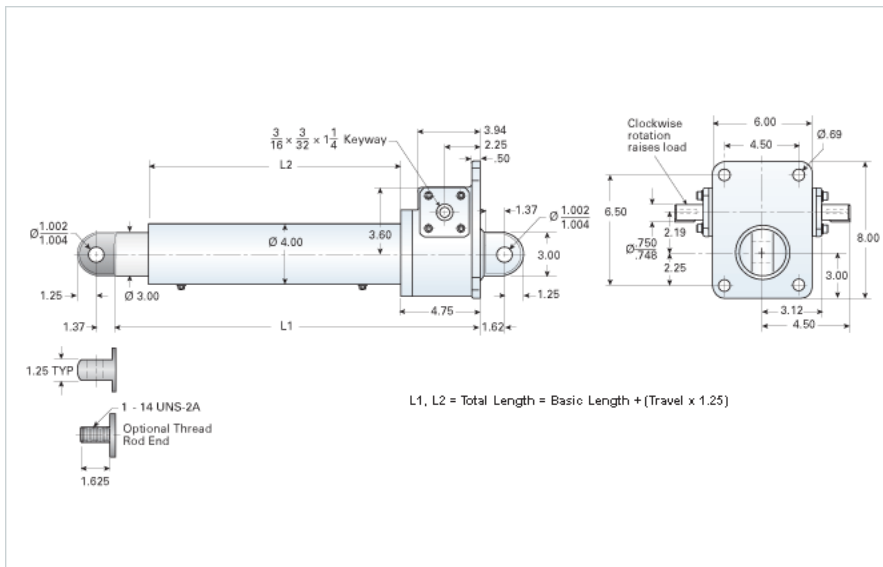

### Details

Gear Ratio	24:1
Max Capacity [lb]	10000
Input Turns Per Inch Of Travel	24
Torque To Raise 1 lb. [in-lb]	0.0073
Ball Screw	1500-1000 SRT RA
Screw Lead [in]	1.000
Root Diameter [in]	1.140
Max HP [hp]	0.75

### Weight

Basic Weight [lb]	63
Per Inch of Travel [lb]	1.92

### Tube Dimensions

L1 Basic Length [in]	15.13
L2 Basic Length [in]	8.88

### NEMA 42 Dimensions

L3 [in]	-
E [in]	-
F [in]	-

### NEMA 48 Dimensions

L3 [in]	-
E [in]	-
F [in]	-

### NEMA 56C Dimensions

L3 [in]	7.25
E [in]	6.75
F [in]	3.75

### NEMA 182TC Dimensions

L3 [in]	8.00
E [in]	9.25

### NEMA 182TC/18TCc Dimensions

F [in]	3.75
--------	------

### NEMA 184TC Dimensions

L3 [in]	-
E [in]	-
F [in]	-

### NEMA 213TC Dimensions

L3 [in]	-
E [in]	-
F [in]	-