

## RAD-5066-HL/10XX

Call 800-321-7800 or visit us online at [www.nookindustries.com](http://www.nookindustries.com) to configure and order your RAD-5066-HL/10XX today!

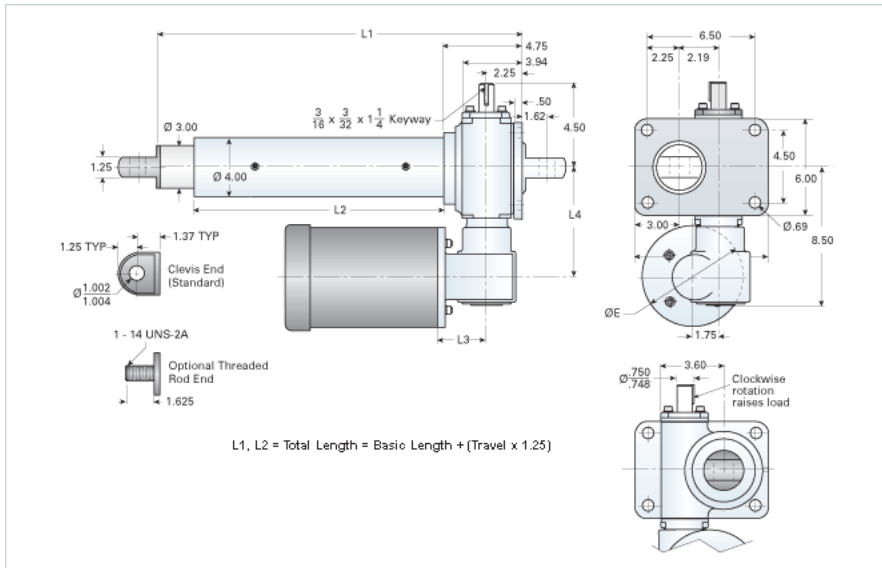

### Performance Specifications

Travel Rate [in/min]	48
Dynamic Capacity [lb]	3500
Rated Life [in]	22000000
Motor Horse Power	1
Maximum Rod Reaction Torque [in-lb]	478
Std. Brake Torque [ft-lb]	6
Approximate Stopping Distance No Load [in]	0.08
Approximate Stopping Distance Full Load [in]	0.08

### Details

Gear Ratio Primary Reduction	6:1
Gear Ratio Secondary Reduction	6:1
Input Turns Per Inch Of Travel	36
Torque To Raise 1 lb. [in-lb]	0.0098
Max Capacity [lb]	10000
Max HP [hp]	1

### Weight

Basic Weight [lb]	77
Per Inch of Travel [lb]	1.92

### Tube Dimensions

L1 Basic Length [in]	15.13
L2 Basic Length [in]	8.88

### NEMA 56C Dimensions

L3 [in]	3.69
L4 [in]	6.50
E [in]	6.69

### NEMA 180TC Dimensions

L3 [in]	-
L4 [in]	-
F [in]	-