

## DD-2008-HD/50XX

Call 800-321-7800 or visit us online at [www.nookindustries.com](http://www.nookindustries.com) to configure and order your DD-2008-HD/50XX today!

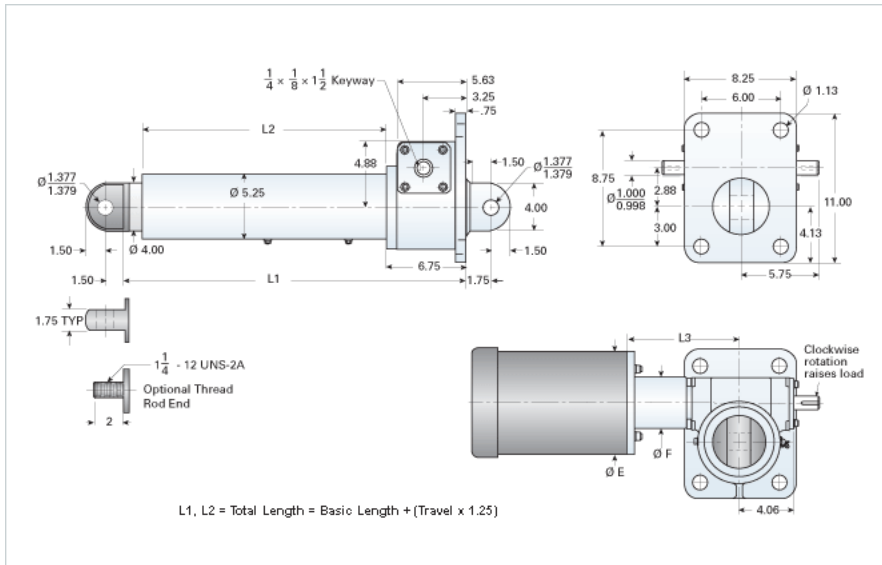

### Performance Specifications

Travel Rate [in/min]	108
Dynamic Capacity [lb]	11000
Rated Life [in]	7300000
Motor Horse Power [hp]	5
Maximum Rod Reaction Torque [in-lb]	979
Std. Brake Torque [ft-lb]	15
Approximate Stopping Distance No Load [in]	0.40
Approximate Stopping Distance Full Load [in]	0.70

### Details

Gear Ratio	8:1
Input Turns Per Inch Of Travel	16
Torque To Raise 1 lb. [in-lb]	0.0157
Max Capacity [lb]	40000
Max HP [hp]	7.5

### Weight

Basic Weight [lb]	154
Per Inch of Travel [lb]	3.31

### Tube Dimensions

L1 Basic Length [in]	21.13
L2 Basic Length [in]	12.63

### NEMA 42 Dimensions

L3 [in]	-
E [in]	-
F [in]	-

### NEMA 48 Dimensions

L3 [in]	-
E [in]	-
F [in]	-

### NEMA 56C Dimensions

L3 [in]	8.65
E [in]	6.75
F [in]	5.19

### NEMA 182TC Dimensions

L3 [in]	-
E [in]	-
F [in]	-

### NEMA 184TC Dimensions

L3 [in]	9.00
E [in]	9.25
F [in]	5.19

### NEMA 213TC Dimensions

L3 [in]	9.65
E [in]	9.25
F [in]	5.69