

## DD-1008-HL/50XX

Call 800-321-7800 or visit us online at [www.nookindustries.com](http://www.nookindustries.com) to configure and order your DD-1008-HL/50XX today!

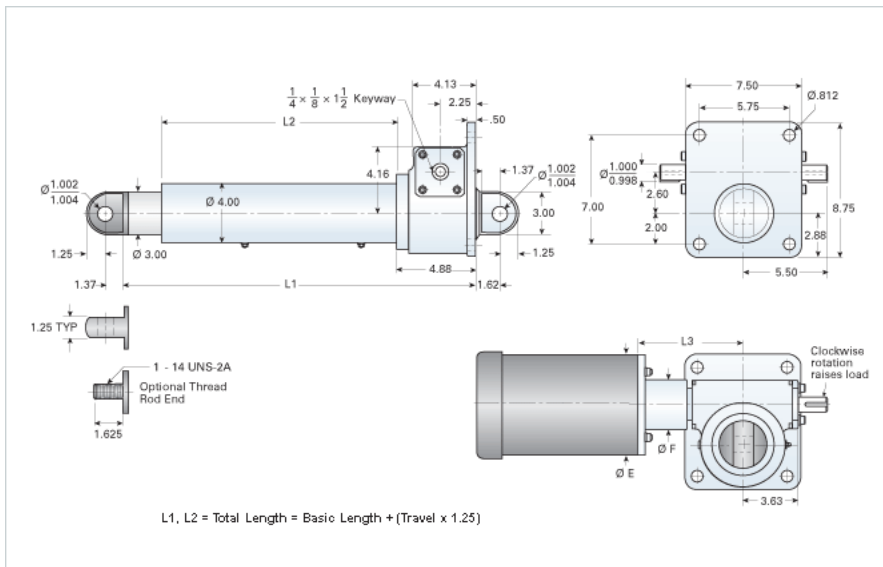

### Performance Specifications

Travel Rate [in/min]	216
Dynamic Capacity [lb]	5400
Rated Life [in]	2700000
Motor Horse Power [hp]	5
Maximum Rod Reaction Torque [in-lb]	956
Std. Brake Torque [ft-lb]	0.7
Approximate Stopping Distance No Load [in]	1.30
Approximate Stopping Distance Full Load [in]	15.00

### Details

Gear Ratio	8:1
Input Turns Per Inch Of Travel	8
Torque To Raise 1 lb. [in-lb]	0.0319
Max Capacity [lb]	20000
Max HP [hp]	5

### Weight

Basic Weight [lb]	80
Per Inch of Travel [lb]	1.92

### Tube Dimensions

L1 Basic Length [in]	15.25
L2 Basic Length [in]	8.88

### NEMA 42 Dimensions

L3 [in]	-
E [in]	-
F [in]	-

### NEMA 48 Dimensions

L3 [in]	-
E [in]	-
F [in]	-

### NEMA 56C Dimensions

L3 [in]	8.25
E [in]	6.75
F [in]	4.38

### NEMA 182TC Dimensions

L3 [in]	-
E [in]	-
F [in]	-

### NEMA 184TC Dimensions

L3 [in]	9.00
E [in]	9.25
F [in]	4.38

### NEMA 213TC Dimensions

L3 [in]	-
E [in]	-
F [in]	-