

DD-256-HL/20XX

Call 800-321-7800 or visit us online at www.nookindustries.com to configure and order your DD-256-HL/20XX today!

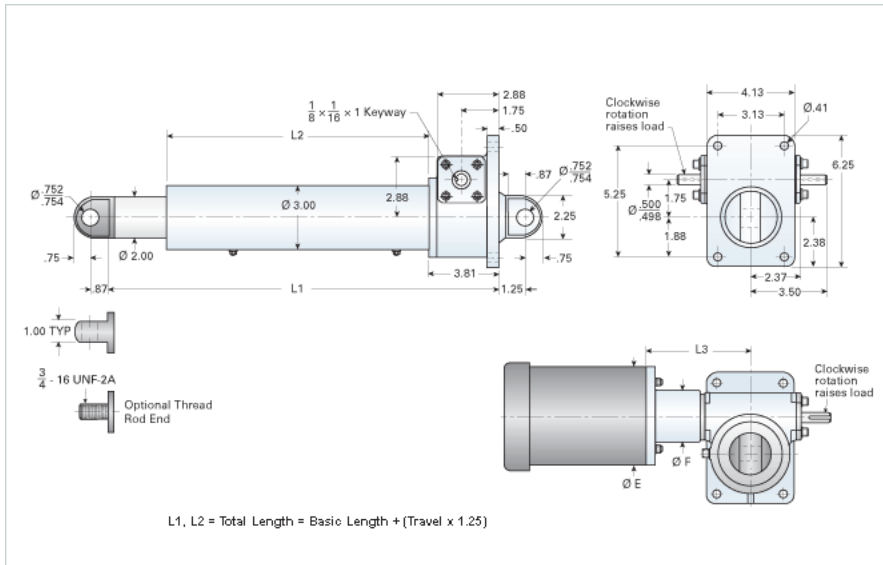

Performance Specifications

Travel Rate [in/min]	288
Dynamic Capacity [lb]	1800
Rated Life [in]	1690000
Motor Horse Power [hp]	2
Maximum Rod Reaction Torque [in-lb]	318
Std. Brake Torque [ft-lb]	0.43
Approximate Stopping Distance No Load [in]	0.74
Approximate Stopping Distance Full Load [in]	10.00

Details

Gear Ratio	6:1
Input Turns Per Inch Of Travel	6
Torque To Raise 1 lb. [in-lb]	0.0404
Max Capacity [lb]	5000
Max HP [hp]	0.2

Weight

Basic Weight [lb]	33
Per Inch of Travel [lb]	1.05

Tube Dimensions

L1 Basic Length [in]	12.44
L2 Basic Length [in]	7.13

NEMA 42 Dimensions

L3 [in]	-
E [in]	-
F [in]	-

NEMA 48 Dimensions

L3 [in]	-
E [in]	-
F [in]	-

NEMA 56C Dimensions

L3 [in]	6.25
E [in]	6.62
F [in]	3.50

NEMA 182TC Dimensions

L3 [in]	-
E [in]	-
F [in]	-

NEMA 184TC Dimensions

L3 [in]	-
E [in]	-
F [in]	-

NEMA 213TC Dimensions

L3 [in]	-
E [in]	-
F [in]	-