

## DD-20008-A3/75XX

Call 800-321-7800 or visit us online at [www.nookindustries.com](http://www.nookindustries.com) to configure and order your DD-20008-A3/75XX today!

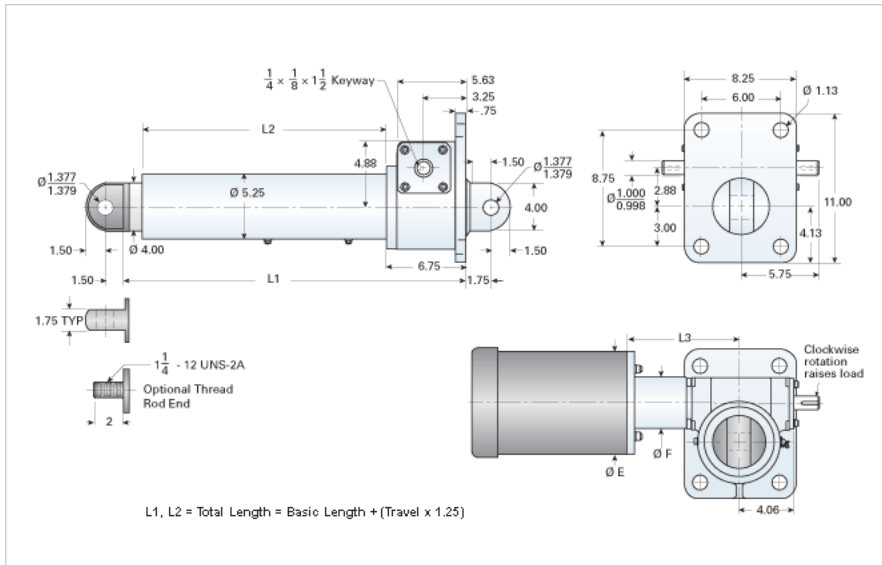

### Performance Specifications

Travel Rate [in/min]	72
Dynamic Capacity [lb]	46250
Motor Horse Power (ref.) [hp]	7.5
Std. Brake Torque [ft-lb]	15
Approximate Stopping Distance No Load [in]	0.24
Maximum Rod Reaction Torque [in-lb]	979

### Details

Gear Ratio	8:1
Input Turns Per Inch Of Travel	24
Torque To Raise 1 lb. [in-lb]	0.0394
Max Capacity [lb]	40000
Max HP [hp]	7.5

### Weight

Basic Weight [lb]	138
Per Inch of Travel [lb]	3.60

### Tube Dimensions

L1 Basic Length [in]	17.44
L2 Basic Length [in]	8.94

### NEMA 42 Dimensions

L3 [in]	-
E [in]	-
F [in]	-

### NEMA 48 Dimensions

L3 [in]	-
E [in]	-
F [in]	-

### NEMA 56C Dimensions

L3 [in]	8.65
E [in]	6.75
F [in]	5.18

### NEMA 182TC Dimensions

L3 [in]	-
E [in]	-
F [in]	-

### NEMA 184TC Dimensions

L3 [in]	-
E [in]	9.25
F [in]	5.19

### NEMA 213TC Dimensions

L3 [in]	9.00
E [in]	9.25
F [in]	5.69