

DSR 120 Extended Carriage

Call 800-321-7800 or visit us online at www.nookindustries.com to configure and order your DSR 120 Extended Carriage today!

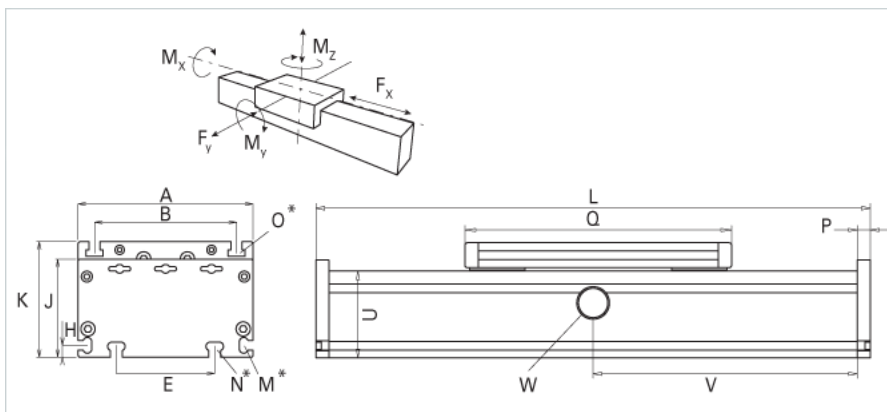

Details	
Size	120
Dimensions	
Basic Length L [mm]	200
A [mm]	120
B [mm]	96
E [mm]	78
H [mm]	10
J [mm]	68
K [mm]	79
M	M6
N	M5
O	M6
P [mm]	10
Q [mm]	156
U [mm]	60
Speed	
Speed Maximum [m/s]	5
Forces and Torques	
Fy [N] 10000 km	1405
Fz [N] 10000 km	1650
Mx [Nm] 10000 km	64
My [Nm] 10000 km	77
Mz [Nm] 10000 km	76
Fy [N] 5000 km	1776
Fz [N] 5000 km	2090
Mx [Nm] 5000 km	81
My [Nm] 5000 km	97
Mz [Nm] 5000 km	96
Geometrical moments of inertia of aluminum profile	
Elastic modulus [N/mm ²]	70000
Ix [mm ⁴]	561000
Iy [mm ⁴]	3419000
Weight	
Additional Weight per 100 mm [kg]	0.71
Basic Weight [kg]	3.2