

QSK 80 Extended Carriage

Call 800-321-7800 or visit us online at www.nookindustries.com to configure and order your QSK 80 Extended Carriage today!

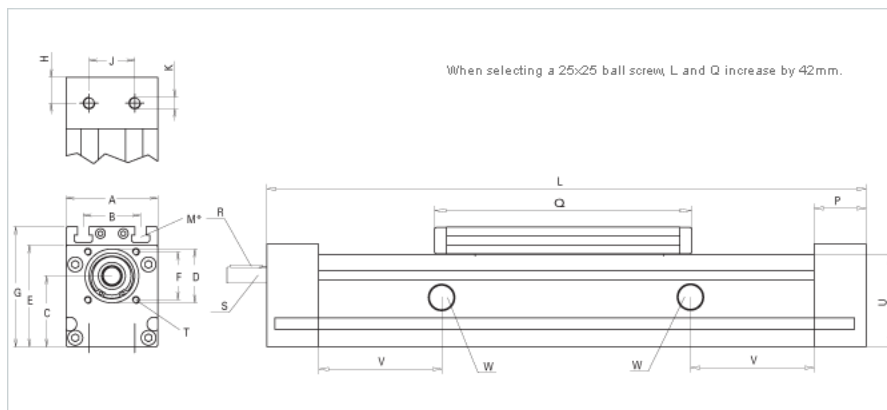
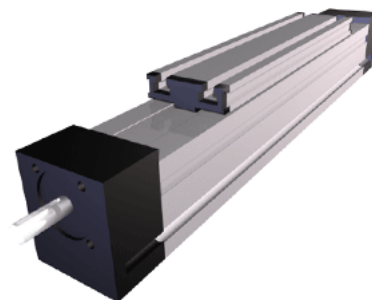

Details	
Size	80
Screw Options	25x5/20x20/25x10/25x25
Screw Type	Ball Screw
Dimensions	
Basic Length L [mm]	436
A [mm]	80
B [mm]	50
C [mm]	62
D [mm]	47
E [mm]	89
F [mm]	42
G [mm]	106
H [mm]	22.5
J [mm]	40
K	M10
M	M8
P [mm]	45
Q [mm]	336
Shaft R Key [mm]	5x5x28
Shaft S Diameter x Length [mm]	14h6x35
T	M6
U [mm]	80
Forces and Torques	
Fx [N] 10000 km	2000
Fy [N] 10000 km	2542
Fz [N] 10000 km	6050
Mx [Nm] 10000 km	76
My [Nm] 10000 km	430
Mz [Nm] 10000 km	392
Fx [N] 5000 km	2500
Fy [N] 5000 km	3570
Fz [N] 5000 km	8500
Mx [Nm] 5000 km	107
My [Nm] 5000 km	604
Mz [Nm] 5000 km	550
Geometrical moments of inertia of aluminum profile	
Elastic modulus [N/mm ²]	70000
Ix [mm ⁴]	1400000
Iy [mm ⁴]	1660000
Weight	
Weight Per 100 mm [kg]	0.9
Basic Weight [kg]	7.5
Motor Details	
Weight Per 100 mm [kg]	0.9
Weight	
Basic Weight [kg]	14.8