

DLR 200 Extended Carriage

Call 800-321-7800 or visit us online at www.nookindustries.com to configure and order your DLR 200 Extended Carriage today!

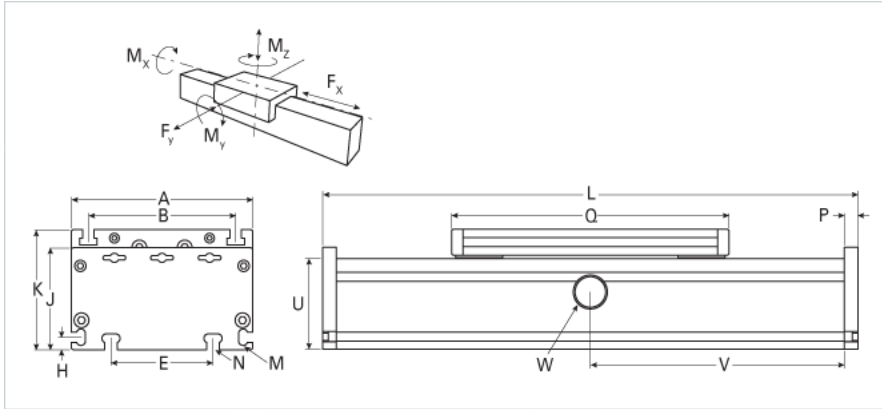
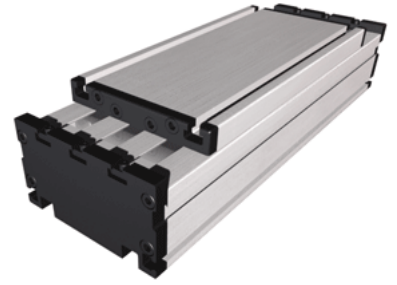

Details	
Size	200
Dimensions	
Basic Length L [mm]	380
A [mm]	200
B [mm]	160
E [mm]	140
H [mm]	15
J [mm]	110
K [mm]	129
M	M8
N	M10
O	M10
P [mm]	15
Q [mm]	330
U [mm]	100
Speed	
Speed Maximum [m/s]	8
Forces and Torques	
Fx dynamic [N]	-
Fy dynamic [N]	3100
Fz dynamic [N]	4400
Mx dynamic [Nm]	510
My dynamic [Nm]	480
Mz dynamic [Nm]	275
Fx static [N]	-
Fy static [N]	4400
Fz static [N]	4900
Mx static [Nm]	600
My static [Nm]	560
Mz static [Nm]	310
Geometrical moments of inertia of aluminum profile	
Elastic modulus [N/mm ²]	70000
Ix [mm ⁴]	6380000
Iy [mm ⁴]	33500000
Weight	
Additional Weight per 100 mm [kg] {.00}	2.3
Basic Weight [kg]	11.4