

## ELZT 40 Extended Carriage

Call 800-321-7800 or visit us online at [www.nookindustries.com](http://www.nookindustries.com) to configure and order your ELZT 40 Extended Carriage today!

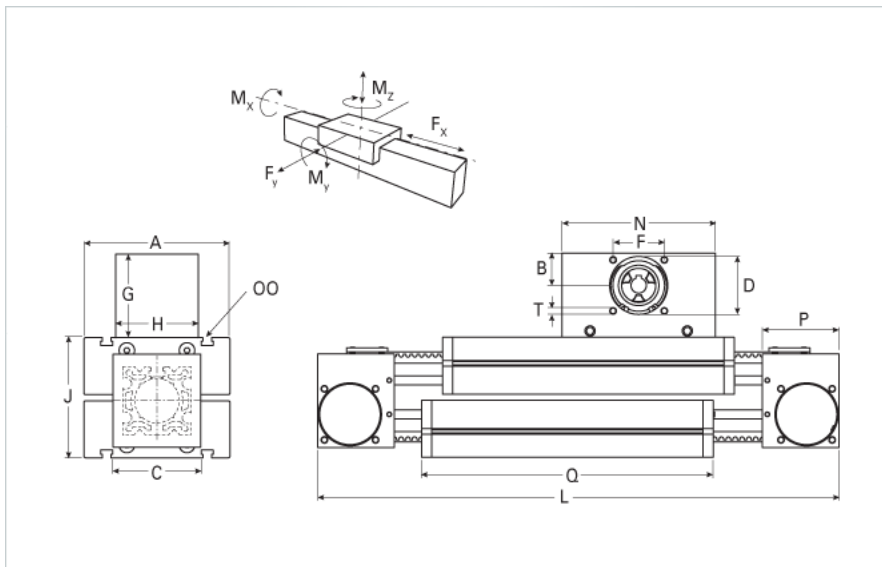
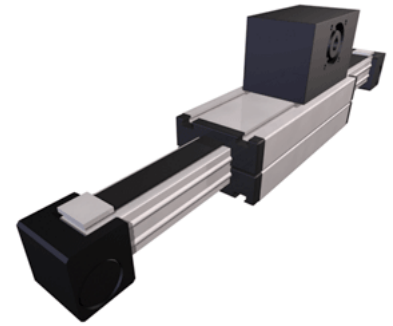

<b>Details</b>	
Size	40
Belt	5M25
mm/Rev	130
Number of Teeth	26
Pully Diameter [mm]	41.4
<b>Dimensions</b>	
Basic Length L [mm]	360
A [mm]	100
B [mm]	30
C [mm]	58
D [mm]	47
F [mm]	42
G [mm]	83
H [mm]	80
I [mm]	-
J [mm]	70
MM	-
N [mm]	130
OO	M6
P [mm]	49
Q [mm]	257
T	M6
V [mm]	-
Shaft Diameter and Length [mm]	14 x 35
Key	5x5x28
<b>Speed</b>	
Speed Maximum [m/s]	4
<b>Forces and Torques</b>	
No-load torque [Nm]	0.9
Tensile force 0.2 sec [N]	450
Tensile force permanent [N]	360
Fy dynamic [N]	700
Fx dynamic [N]	600
Fz dynamic [N]	650
Mx dynamic [Nm]	20
My dynamic [Nm]	18
Mz dynamic [Nm]	285
Fx static [N]	360
Fy static [N]	1200
Fz static [N]	900
Mx static [Nm]	25
My static [Nm]	32
Mz static [Nm]	35
<b>Geometrical moments of inertia of aluminum profile</b>	
Elastic modulus [N/mm <sup>2</sup> ]	70000
Ix [mm <sup>4</sup> ]	132000

ly [mm <sup>4</sup> ]	134000
<b>Weight</b>	
Additional Weight per 100 mm [kg]	0.31
Basic Weight [kg]	3.6