

ELSD 60 Wide Belt Extended Carriage

Call 800-321-7800 or visit us online at www.nookindustries.com to configure and order your ELSD 60 Wide Belt Extended Carriage today!

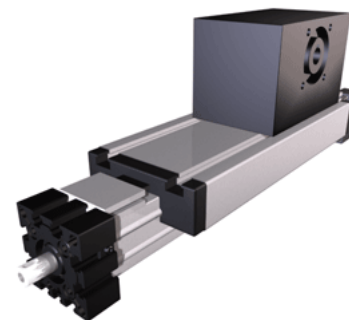

Details	
Size	60
Belt	8M30
mm/Rev	192
Number of Teeth	24
Pully Diameter [mm]	61.1
Dimensions	
Basic Length L [mm]	469
A [mm]	144
B [mm]	39
C [mm]	82
D [mm]	68
E [mm]	30
F [mm]	60
G [mm]	105
H [mm]	100
I [mm]	-
J [mm]	49
K [mm]	8.5
M [mm]	69
MM	-
N [mm]	180
OO	M8
P [mm]	35
Q [mm]	353
T	M8
X [mm]	-
V (Z Drive End) [mm]	14 x 25
U (Z Drive End) [mm]	5x5x20
V (Z Load End) [mm]	17 x 25
U (Z Load End) [mm]	5x5x20
W (Z Load End) [mm]	M8x20
Shaft Diameter and Length [mm]	14 x 35
Key	5x5x28
Speed	
Speed Maximum [m/s]	5
Forces and Torques	
No-load torque Stiction torque Mr [Nm]	0.1
No-load torque [Nm]	0.9
Tensile force 0.2 sec [N]	2090
Tensile force permanent [N]	1900
Fd [N]	150
Mr [Nm]	10
Fx dynamic [N]	1800
Fy dynamic [N]	2000
Fz dynamic [N]	1100
Mx dynamic [Nm]	43

My dynamic [Nm]	70
Mz dynamic [Nm]	100
Fx static [N]	1900
Fy static [N]	3000
Fz static [N]	1700
Mx static [Nm]	67
My static [Nm]	90
Mz static [Nm]	120
Geometrical moments of inertia of aluminum profile	
Elastic modulus [N/mm ²]	70000
Ix [mm ⁴]	679000
Iy [mm ⁴]	697000
Weight	
Additional Weight per 100 mm [kg]	0.87
Basic Weight [kg]	6.5