

## ELSZ 30 WAC Wide Belt Extended Carriage

Call 800-321-7800 or visit us online at [www.nookindustries.com](http://www.nookindustries.com) to configure and order your ELSZ 30 WAC Wide Belt Extended Carriage today!

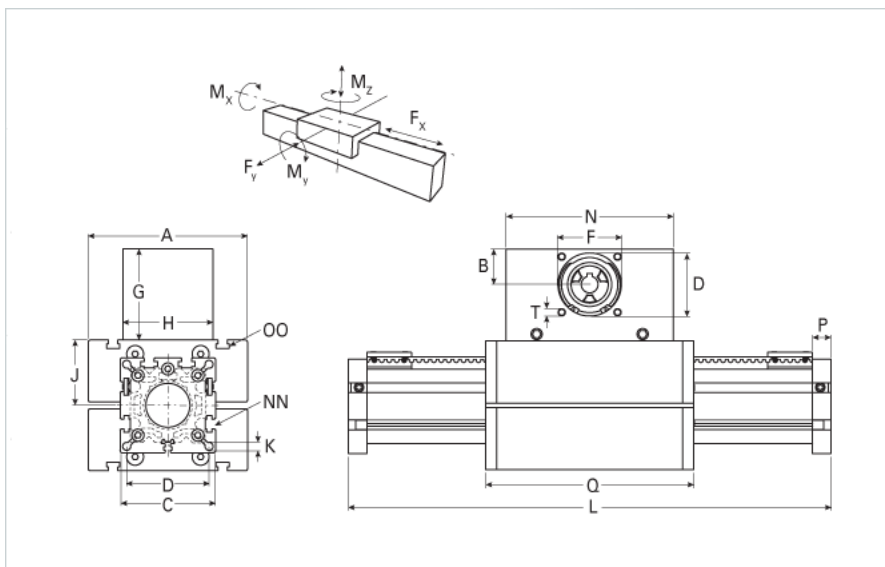
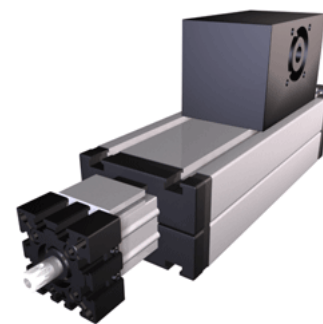

<b>Details</b>	
Size	30
Belt	5M15
mm/Rev	100
Number of Teeth	20
<b>Dimensions</b>	
Basic Length L [mm]	291
A [mm]	70
B [mm]	20
C [mm]	42
D [mm]	37
E [mm]	13
F [mm]	32
G [mm]	55
H [mm]	60
I [mm]	-
J [mm]	26
K [mm]	4.2
MM	-
N [mm]	110
NN	M6
O [mm]	35
OO	M6
P [mm]	12
Q [mm]	207
T	M5
V [mm]	-
Shaft Diameter and Length [mm]	10X 27
Key	3x3x25
<b>Speed</b>	
Speed Maximum [m/s]	2
<b>Forces and Torques</b>	
No-load torque [Nm]	0.5
Tensile force 0.2 sec [N]	480
Tensile force permanent [N]	390
Fx dynamic [N]	350
Fy dynamic [N]	60
Fz dynamic [N]	60
Mx dynamic [Nm]	5
My dynamic [Nm]	6
Mz dynamic [Nm]	7
Fx static [N]	390
Fy static [N]	90
Fz static [N]	90
Mx static [Nm]	10
My static [Nm]	13
Mz static [Nm]	14

**Geometrical moments of inertia of aluminum profile**

Elastic modulus [N/mm <sup>2</sup> ]	70000
I <sub>x</sub> [mm <sup>4</sup> ]	40900
I <sub>y</sub> [mm <sup>4</sup> ]	40000

**Weight**

Additional Weight per 100 mm [kg]	0.16
Basic Weight [kg]	1.5

**Values for Calculating Inertias**

Pulley Material - Drive Pulley (x1)	Steel
Pulley Material - Idler Pulleys (x2)	Plastic
Pulley Diameter [mm]	31.8
Effective Pulley Width [mm]	60
Belt Weight [kg/m]	0.037
Standard Carriage Weight [kg]	1.33
No-load torque [Nm]	0.5
Friction Coefficient	0.01