

ELSZ 40 WAC Wide Belt

Call 800-321-7800 or visit us online at www.nookindustries.com to configure and order your ELSZ 40 WAC Wide Belt today!

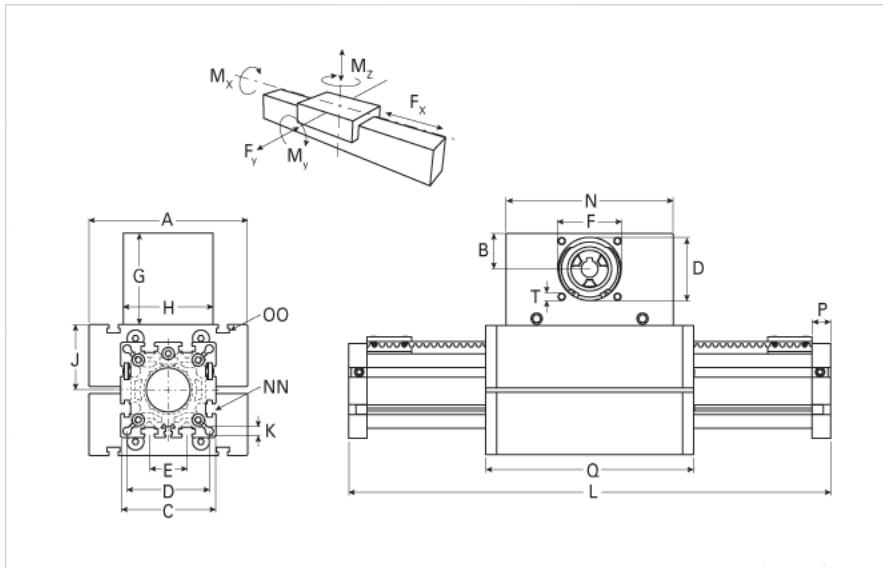
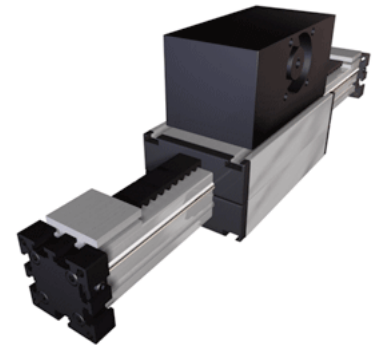

Details

Size	40
Belt	5M25
mm/Rev	130
Number of Teeth	26
Pully Diameter [mm]	41.4

Dimensions

Basic Length L [mm]	276
A [mm]	100
B [mm]	30
C [mm]	58
D [mm]	47
E [mm]	25
F [mm]	42
G [mm]	83
H [mm]	80
I [mm]	-
J [mm]	35
K [mm]	6.5
MM	-
N [mm]	130
NN	M6
O [mm]	47
OO	M6
P [mm]	12
Q [mm]	164
T	M6
V [mm]	-
Shaft Diameter and Length [mm]	14 x 35
Key	5x5x28

Speed

Speed Maximum [m/s]	4
---------------------	---

Forces and Torques

No-load torque [Nm]	0.7
Tensile force 0.2 sec [N]	480
Tensile force permanent [N]	894
Fx dynamic [N]	800
Fy dynamic [N]	700
Fz dynamic [N]	650
Mx dynamic [Nm]	20
My dynamic [Nm]	18
Mz dynamic [Nm]	25
Fx static [N]	894
Fy static [N]	1200
Fz static [N]	900
Mx static [Nm]	25
My static [Nm]	32

Mz static [Nm]	35
Geometrical moments of inertia of aluminum profile	
Elastic modulus [N/mm ²]	70000
Ix [mm ⁴]	132000
Iy [mm ⁴]	134000
Weight	
Additional Weight per 100 mm [kg]	0.24
Basic Weight [kg]	2.7