

## ELSZ 40 WAC Extended Carriage

Call 800-321-7800 or visit us online at [www.nookindustries.com](http://www.nookindustries.com) to configure and order your ELSZ 40 WAC Extended Carriage today!

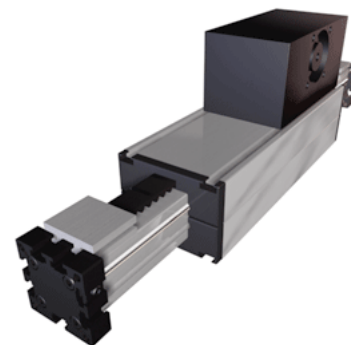
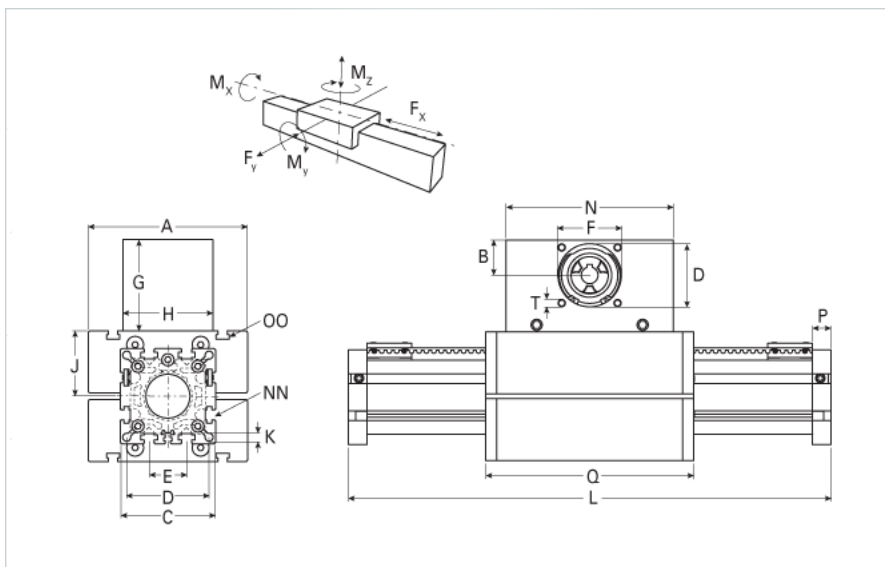

<b>Details</b>	
Size	40
Belt	5M15
mm/Rev	100
Number of Teeth	20
Pully Diameter [mm]	31.8
<b>Dimensions</b>	
Basic Length L [mm]	341
A [mm]	100
B [mm]	20
C [mm]	58
D [mm]	37
E [mm]	25
F [mm]	32
G [mm]	65
H [mm]	60
I [mm]	-
J [mm]	35
K [mm]	6.5
MM	-
N [mm]	110
NN	M6
O [mm]	47
OO	M6
P [mm]	12
Q [mm]	253
T	M5
V [mm]	-
Shaft Diameter and Length [mm]	10X 27
Key	3x3x25
<b>Speed</b>	
Speed Maximum [m/s]	4
<b>Forces and Torques</b>	
No-load torque [Nm]	0.7
Tensile force 0.2 sec [N]	480
Tensile force permanent [N]	390
Fx dynamic [N]	350
Fy dynamic [N]	700
Fz dynamic [N]	650
Mx dynamic [Nm]	20
My dynamic [Nm]	18
Mz dynamic [Nm]	25
Fx static [N]	390
Fy static [N]	1200
Fz static [N]	900
Mx static [Nm]	25
My static [Nm]	32

Mz static [Nm]	35
<b>Geometrical moments of inertia of aluminum profile</b>	
Elastic modulus [N/mm <sup>2</sup> ]	70000
Ix [mm <sup>4</sup> ]	132000
Iy [mm <sup>4</sup> ]	134000
<b>Weight</b>	
Additional Weight per 100 mm [kg]	0.24
Basic Weight [kg]	2.1