

NU35ER Assembly

Call 800-321-7800 or visit us online at www.nookindustries.com to configure and order your NU35ER Assembly today!

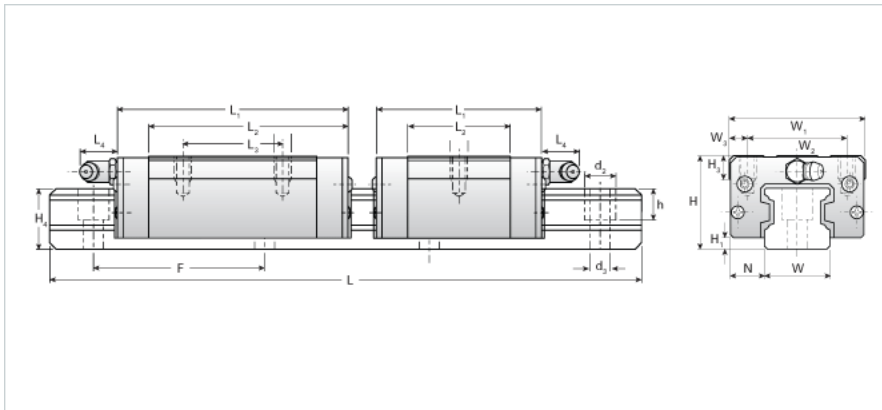

Dimensions	
H [mm]	48
H1 [mm]	8
N [mm]	18.0
Metric Profile Rail	
Details	
Size [mm]	35
Type	Compact
Dimensions	
d2 [mm]	14
d3 [mm]	9
h [mm]	15
H4 [mm]	32
F [mm]	80
W [mm]	34
Maximum Length [mm]	3000
Weight	
Weights-Rail [kg/m]	7.5
Metric Runner Block, Heavy Load, Compact Type, 4 Tapped Holes	
Details	
Size [mm]	35
Dimensions	
L1 [mm]	112
L2 [mm]	80
L3 [mm]	50
L4 [mm]	12
H3 [mm]	10
M1 x l	M8X12
W1 [mm]	70
W2 [mm]	50
W3 [mm]	10
Forces and Torques	
Basic Load Ratings C [kN]	37.55
Basic Load Ratings C [lbf]	8441
Basic Load Ratings C0 [kN]	62.55
Basic Load Ratings C0 [lbf]	14061
Static Moment Ratings-Ma [kN-m]	0.64
Static Moment Ratings-Ma [lb-in]	5642
Static Moment Ratings-Mb [kN-m]	0.64
Static Moment Ratings-Mb [lb-in]	5642
Static Moment Ratings-Mc [kN-m]	1.13
Static Moment Ratings-Mc [lb-in]	9982
Weight	
Weight-Block [kg]	1.30
Grease Fitting	
Grease Fitting Part Number	B-M6F