

NH65EB Assembly

Call 800-321-7800 or visit us online at www.nookindustries.com to configure and order your NH65EB Assembly today!

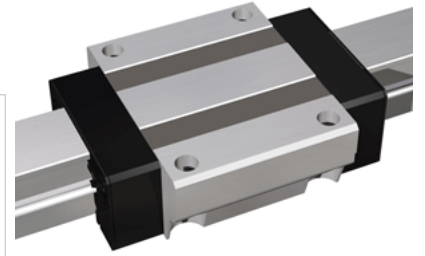
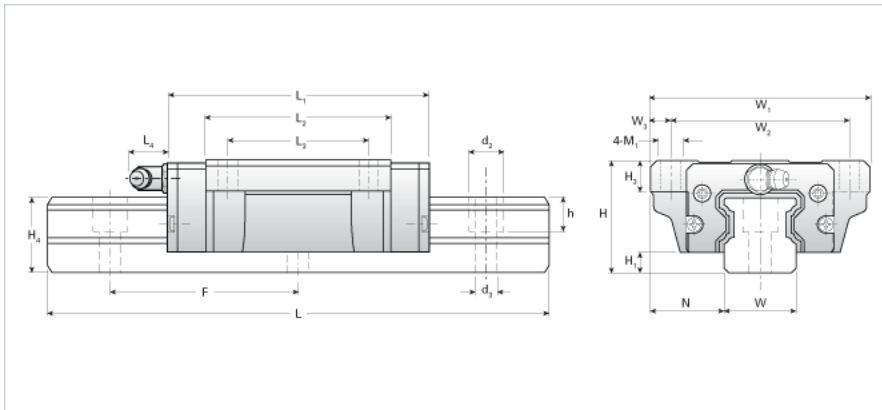

Dimensions	
H [mm]	85
H1 [mm]	14
N [mm]	53.5
Metric Profile Rail	
Details	
Size [mm]	65
Type	Standard
Dimensions	
d2 [mm]	26
d3 [mm]	18
h [mm]	25
H4 [mm]	58
F [mm]	150
W [mm]	63
Maximum Length [mm]	3000
Weight	
Weights-Rail [kg/m]	24.9
Metric Runner Block, Heavy Load, Flange Type, 4 Through Holes	
Details	
Size [mm]	65
Dimensions	
L1 [mm]	199
L2 [mm]	148
L3 [mm]	110
L4 [mm]	16
H3 [mm]	20
M1 [mm]	16
W1 [mm]	170
W2 [mm]	142
W3 [mm]	14
D1 [mm]	16
Forces and Torques	
Basic Load Ratings C [kN]	141.11
Basic Load Ratings C [lbf]	31714
Basic Load Ratings C0 [kN]	215.15
Basic Load Ratings C0 [lbf]	48354
Static Moment Ratings-Ma [kN-m]	4.21
Static Moment Ratings-Ma [lb-in]	37237
Static Moment Ratings-Mb [kN-m]	4.21
Static Moment Ratings-Mb [lb-in]	37237
Static Moment Ratings-Mc [kN-m]	7.38
Static Moment Ratings-Mc [lb-in]	65360
Weight	
Weight-Block [kg]	9.10
Grease Fitting	
Grease Fitting Part Number	B-PT 1/8