

NH55EA Assembly

Call 800-321-7800 or visit us online at www.nookindustries.com to configure and order your NH55EA Assembly today!

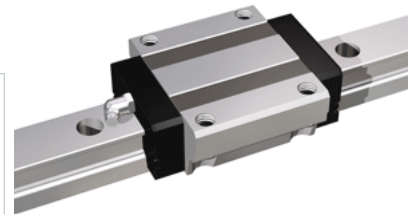
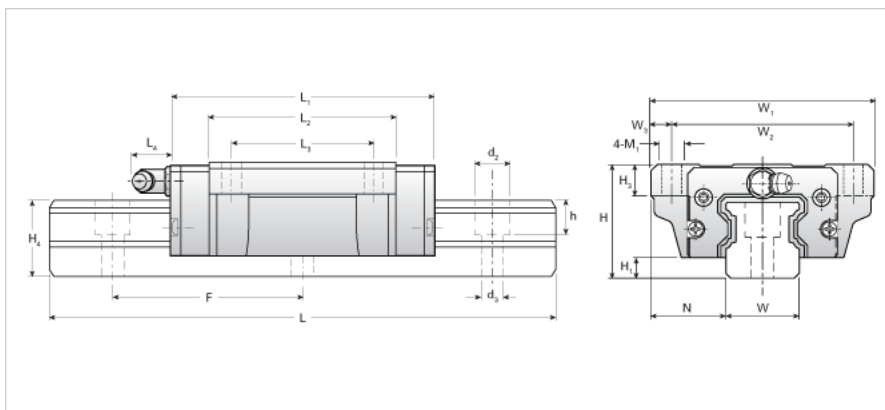

Dimensions	
H [mm]	70
H1 [mm]	14
N [mm]	48.0
Metric Profile Rail	
Details	
Size [mm]	55
Type	Standard
Dimensions	
d2 [mm]	23
d3 [mm]	16
h [mm]	24
H4 [mm]	48
F [mm]	120
W [mm]	53
Maximum Length [mm]	3000
Weight	
Weights-Rail [kg/m]	16.5
Metric Runner Block, Heavy Load, Flange Type, 4 Tapped Holes	
Details	
Size [mm]	55
Dimensions	
L1 [mm]	159
L2 [mm]	124
L3 [mm]	95
L4 [mm]	16
H3 [mm]	17
W1 [mm]	140
W2 [mm]	116
W3 [mm]	12
M1	M14
Forces and Torques	
Basic Load Ratings C [kN]	90.02
Basic Load Ratings C [lbf]	20232
Basic Load Ratings C0 [kN]	137.09
Basic Load Ratings C0 [lbf]	30811
Static Moment Ratings-Ma [kN-m]	2.22
Static Moment Ratings-Ma [lb-in]	19617
Static Moment Ratings-Mb [kN-m]	2.22
Static Moment Ratings-Mb [lb-in]	19617
Static Moment Ratings-Mc [kN-m]	4.16
Static Moment Ratings-Mc [lb-in]	37671
Weight	
Weight-Block [kg]	5.10
Grease Fitting	
Grease Fitting Part Number	B-PT 1/8