

## NH45TR Assembly

Call 800-321-7800 or visit us online at [www.nookindustries.com](http://www.nookindustries.com) to configure and order your NH45TR Assembly today!

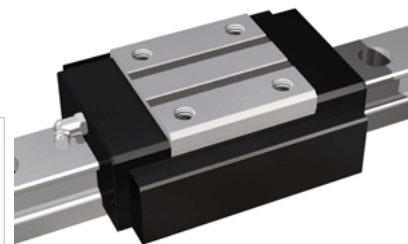
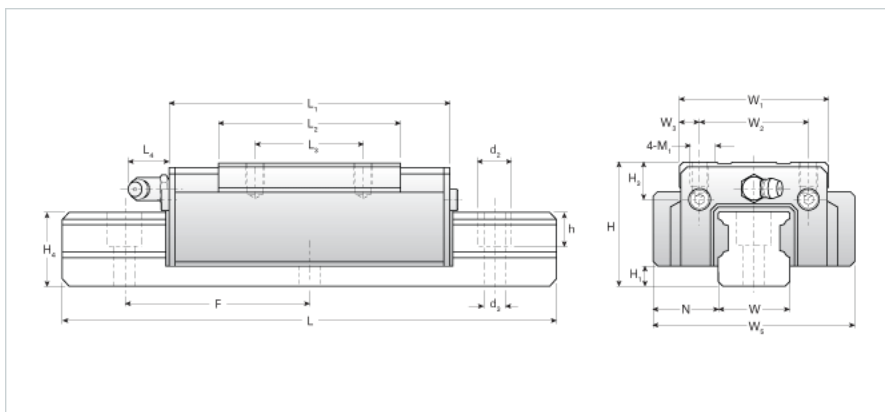

<b>Dimensions</b>	
H [mm]	70
H1 [mm]	11
N [mm]	20.5
<b>Metric Profile Rail</b>	
<b>Details</b>	
Size [mm]	45
Type	Standard
<b>Dimensions</b>	
d2 [mm]	20
d3 [mm]	14
h [mm]	21
H4 [mm]	42
F [mm]	105
W [mm]	45
Maximum Length [mm]	3000
<b>Weight</b>	
Weights-Rail [kg/m]	12.9
<b>Metric Runner Block, Heavy Load, High Speed, 4 Tapped Holes On Runner Block</b>	
<b>Details</b>	
Size [mm]	45
<b>Dimensions</b>	
H3 [mm]	15
L1 [mm]	158
L2 [mm]	102
L3 [mm]	60
L4 [mm]	15
M1 x l	M10X17
W1 [mm]	86
W2 [mm]	60
W3 [mm]	13
W5 [mm]	112
<b>Forces and Torques</b>	
Basic Load Ratings C [kN]	60.20
Basic Load Ratings C [lbf]	13532
Basic Load Ratings C0 [kN]	95.71
Basic Load Ratings C0 [lbf]	21510
Static Moment Ratings-Ma [kN-m]	1.30
Static Moment Ratings-Ma [lb-in]	11544
Static Moment Ratings-Mb [kN-m]	1.30
Static Moment Ratings-Mb [lb-in]	11544
Static Moment Ratings-Mc [kN-m]	2.30
Static Moment Ratings-Mc [lb-in]	20398
<b>Weight</b>	
Weight-Block [kg]	2.80
<b>Grease Fitting</b>	
Grease Fitting Part Number	B-PT 1/8