

## NH30LER Assembly

Call 800-321-7800 or visit us online at [www.nookindustries.com](http://www.nookindustries.com) to configure and order your NH30LER Assembly today!

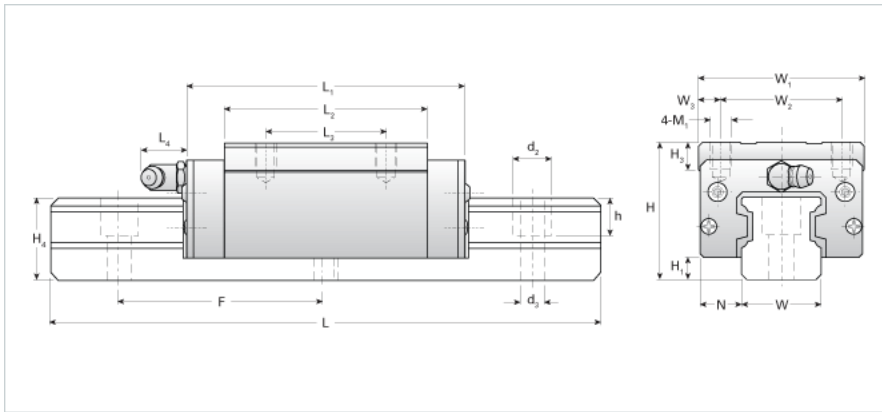

<b>Dimensions</b>	
H [mm]	45
H1 [mm]	7
N [mm]	16.0
<b>Metric Profile Rail</b>	
<b>Details</b>	
Size [mm]	30
Type	Standard
<b>Dimensions</b>	
d2 [mm]	14
d3 [mm]	9
h [mm]	14
H4 [mm]	28
F [mm]	80
W [mm]	28
Maximum Length [mm]	4000
<b>Weight</b>	
Weights-Rail [kg/m]	5.3
<b>Metric Runner Block, Ultra Heavy Load, Narrow Width, 4 Tapped Holes</b>	
<b>Details</b>	
Size [mm]	30
<b>Dimensions</b>	
L1 [mm]	123
L2 [mm]	94
L3 [mm]	60
L4 [mm]	12
M1 x l	M8X10
H3 [mm]	8
W1 [mm]	60
W2 [mm]	40
W3 [mm]	10
<b>Forces and Torques</b>	
Basic Load Ratings C [kN]	37.55
Basic Load Ratings C [lbf]	8441
Basic Load Ratings C0 [kN]	62.56
Basic Load Ratings C0 [lbf]	14061
Static Moment Ratings-Ma [kN-m]	0.73
Static Moment Ratings-Ma [lb-in]	6423
Static Moment Ratings-Mb [kN-m]	0.73
Static Moment Ratings-Mb [lb-in]	6423
Static Moment Ratings-Mc [kN-m]	0.98
Static Moment Ratings-Mc [lb-in]	8680
<b>Weight</b>	
Weight-Block [kg]	1.40
<b>Grease Fitting</b>	
Grease Fitting Part Number	B-M6F