

Type 5N, End Code 17

Call 800-321-7800 or visit us online at www.nookindustries.com to configure and order your Type 5N, End Code 17 today!

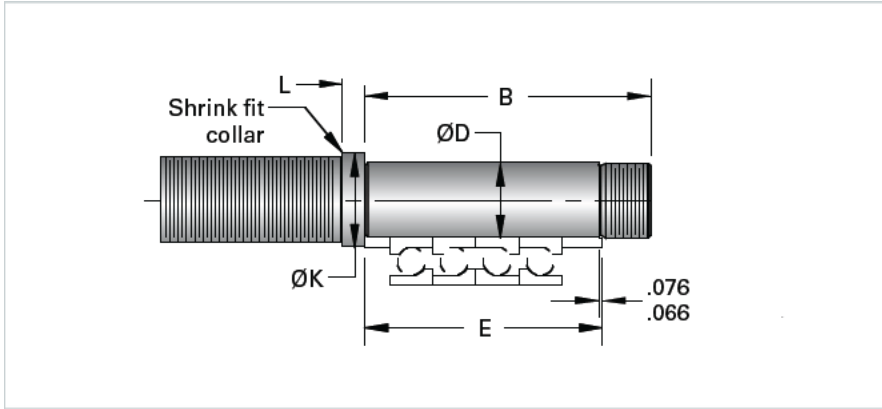

Product Info

Nominal Bearing Journal Size [mm]

17

Dimensions

B [mm]

79

D Maximum [mm]

17.008

D Minimum [mm]

16.997

E [mm]

80

K [mm]

24

L [mm]

9

Lock Nut

SFZ 17X1