

Type 5L, End Code 40

Call 800-321-7800 or visit us online at www.nookindustries.com to configure and order your Type 5L, End Code 40 today!

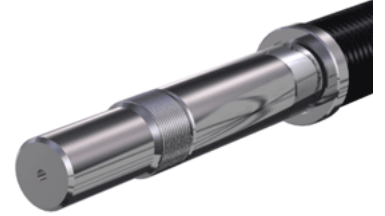
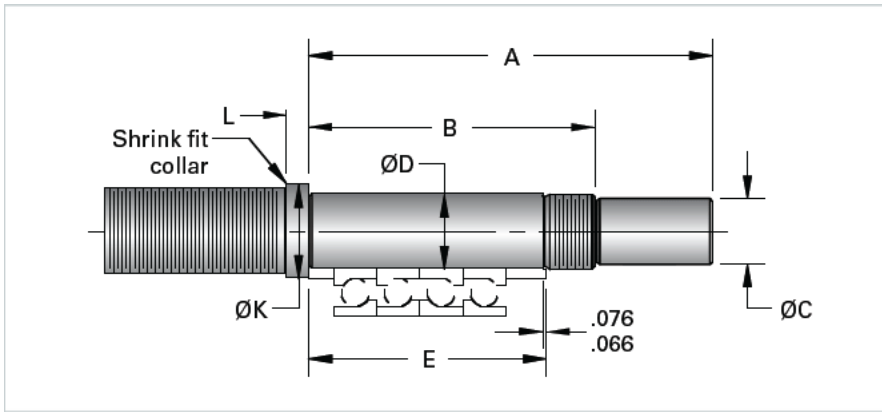

Product Info

Nominal Bearing Journal Size [mm]

40

Dimensions

A [mm]

216

B [mm]

153

C Maximum [mm]

35.00

C Minimum [mm]

34.97

D Maximum [mm]

40.011

D Minimum [mm]

44.995

E [mm]

127

K [mm]

50

L [mm]

12

Lock Nut

SFZ 40X1.5