

Type 5L, End Code 15

Call 800-321-7800 or visit us online at www.nookindustries.com to configure and order your Type 5L, End Code 15 today!

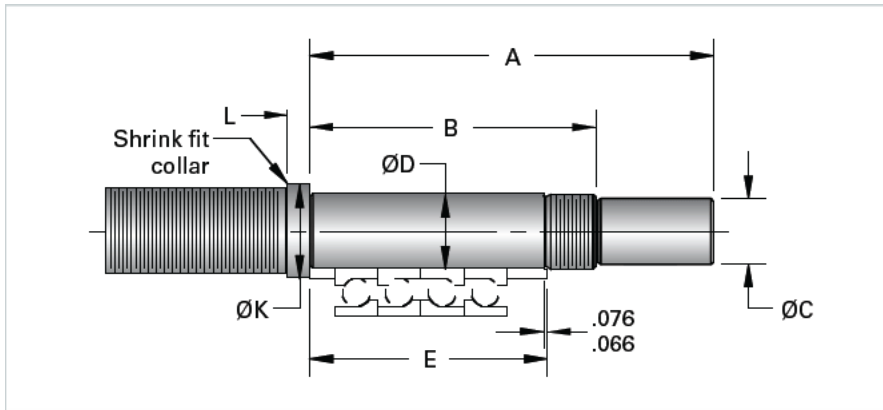

Product Info

Nominal Bearing Journal Size [mm]

15

Dimensions

A [mm]

133

B [mm]

93

C Maximum [mm]

12.00

C Minimum [mm]

11.97

D Maximum [mm]

45.008

D Minimum [mm]

14.997

E [mm]

74

K [mm]

22

L [mm]

9

Lock Nut

SFZ 15X1