

Type 5L, End Code 12

Call 800-321-7800 or visit us online at www.nookindustries.com to configure and order your Type 5L, End Code 12 today!

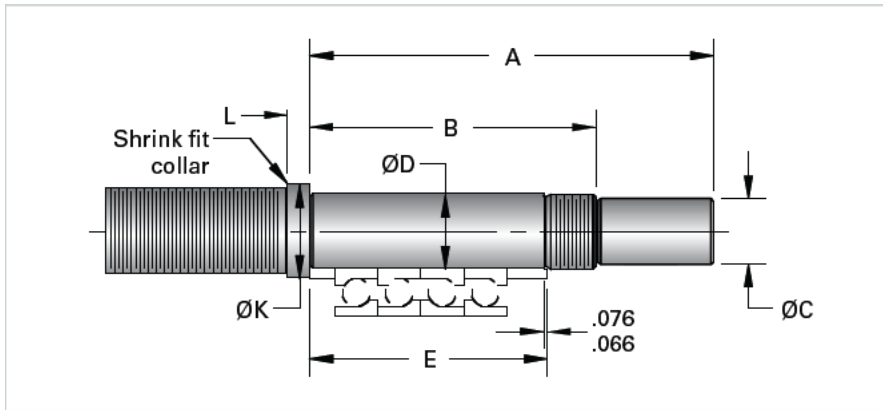

Product Info

Nominal Bearing Journal Size [mm]

12

Dimensions

A [mm]

117

B [mm]

85

C Maximum [mm]

10.00

C Minimum [mm]

9.97

D Maximum [mm]

12.008

D Minimum [mm]

11.997

E [mm]

69

K [mm]

18

L [mm]

8

Lock Nut

SFZ 12X1