

## Type 5K, End Code 75

Call 800-321-7800 or visit us online at [www.nookindustries.com](http://www.nookindustries.com) to configure and order your Type 5K, End Code 75 today!

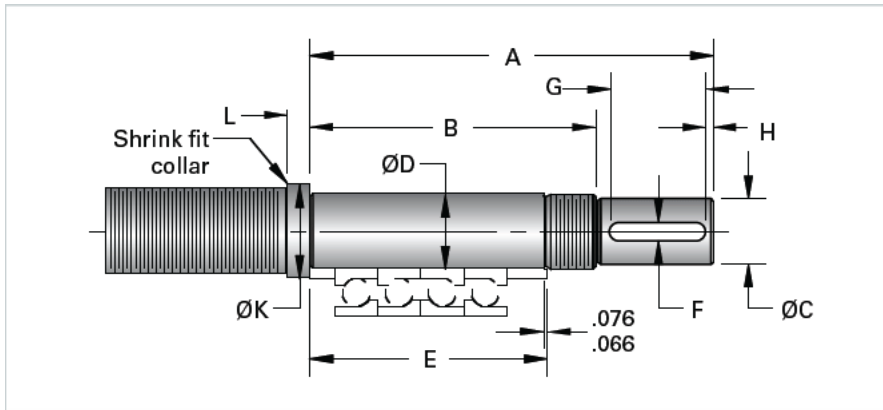

### Product Info

Nominal Bearing Journal Size [mm]

75

### Dimensions

A [mm]

346

B [mm]

232

C Maximum [mm]

65

C Minimum [mm]

64.97

D Maximum [mm]

75.012

D Minimum [mm]

74.993

E [mm]

198

F [mm]

18

G [mm]

91

H [mm]

8

K [mm]

90

L [mm]

18

Lock Nut

SFZ 75X2