

## Type 5K, End Code 60

Call 800-321-7800 or visit us online at [www.nookindustries.com](http://www.nookindustries.com) to configure and order your Type 5K, End Code 60 today!

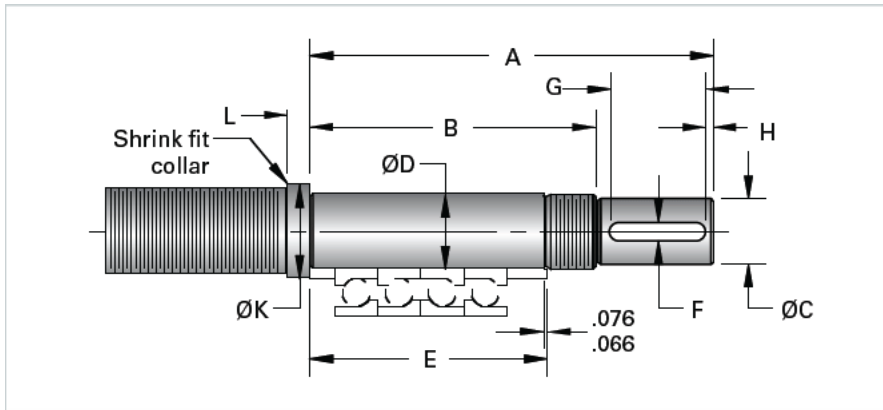

### Product Info

Nominal Bearing Journal Size [mm]

60

### Dimensions

A [mm]

291

B [mm]

202

C Maximum [mm]

55

C Minimum [mm]

54.97

D Maximum [mm]

60.012

D Minimum [mm]

59.993

E [mm]

171

F [mm]

16

G [mm]

71

H [mm]

6

K [mm]

75

L [mm]

16

Lock Nut

SFZ 60X2