

## Type 5K, End Code 45

Call 800-321-7800 or visit us online at [www.nookindustries.com](http://www.nookindustries.com) to configure and order your Type 5K, End Code 45 today!

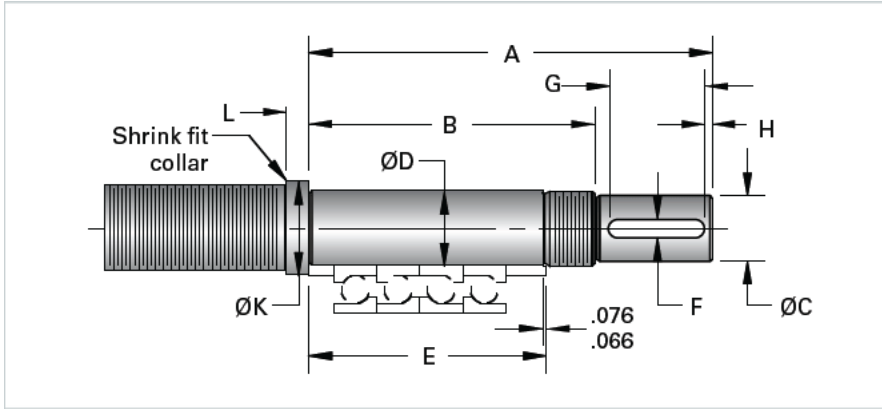

### Product Info

Nominal Bearing Journal Size [mm] 45

### Dimensions

A [mm]	228
B [mm]	163
C Maximum [mm]	40
C Minimum [mm]	39.97
D Maximum [mm]	45.011
D Minimum [mm]	44.995
E [mm]	137
F [mm]	12
G [mm]	51
H [mm]	5
K [mm]	55
L [mm]	12
Lock Nut	SFZ 45X1.5