

## Type 5K, End Code 35

Call 800-321-7800 or visit us online at [www.nookindustries.com](http://www.nookindustries.com) to configure and order your Type 5K, End Code 35 today!

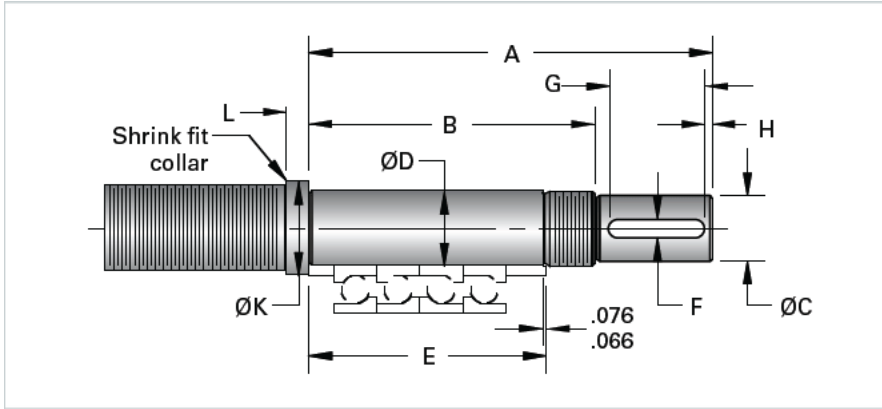

### Product Info

Nominal Bearing Journal Size [mm]

35

### Dimensions

A [mm]

205

B [mm]

143

C Maximum [mm]

30

C Minimum [mm]

29.97

D Maximum [mm]

35.011

D Minimum [mm]

34.995

E [mm]

117

F [mm]

8

G [mm]

51

H [mm]

4

K [mm]

45

L [mm]

10

Lock Nut

SFZ 35X1.5