

## Type 5K, End Code 17

Call 800-321-7800 or visit us online at [www.nookindustries.com](http://www.nookindustries.com) to configure and order your Type 5K, End Code 17 today!

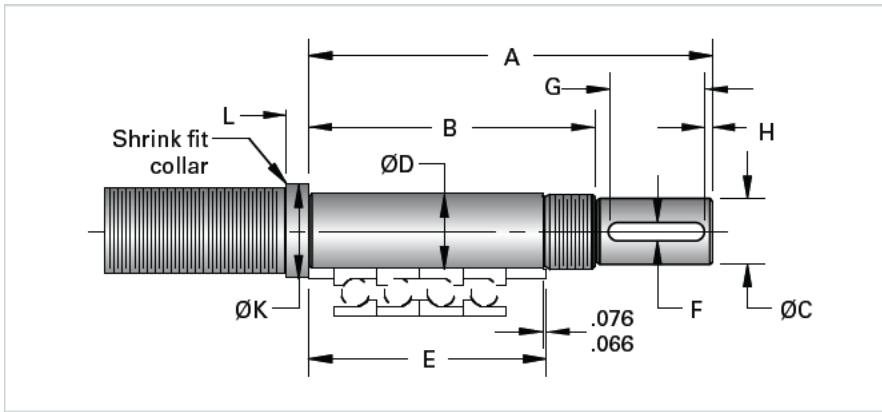

### Product Info

Nominal Bearing Journal Size [mm]

17

### Dimensions

A [mm]

141

B [mm]

79

C Maximum [mm]

15

C Minimum [mm]

14.97

D Maximum [mm]

17.008

D Minimum [mm]

16.997

E [mm]

80

F [mm]

5

G [mm]

33

H [mm]

3

K [mm]

24

L [mm]

9

Lock Nut

SFZ 17X1