

Type 5K, End Code 15

Call 800-321-7800 or visit us online at www.nookindustries.com to configure and order your Type 5K, End Code 15 today!

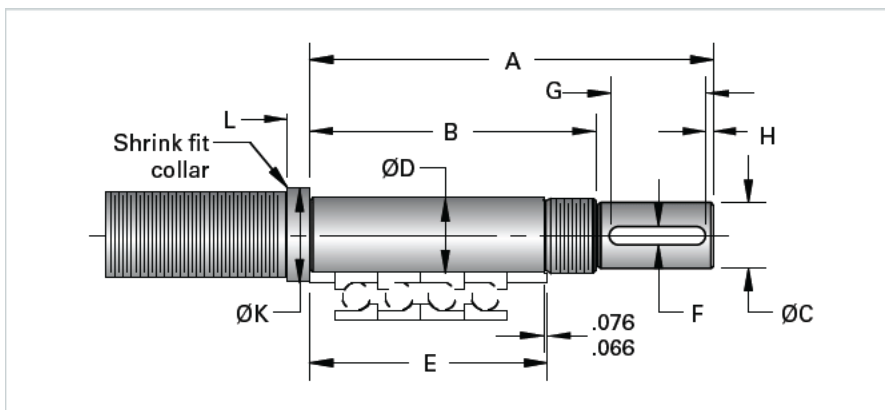

Product Info

Nominal Bearing Journal Size [mm]

15

Dimensions

A [mm]

133

B [mm]

93

C Maximum [mm]

12

C Minimum [mm]

11.97

D Maximum [mm]

45.008

D Minimum [mm]

14.997

E [mm]

74

F [mm]

4

G [mm]

33

H [mm]

3

K [mm]

22

L [mm]

9

Lock Nut

SFZ 15X1